

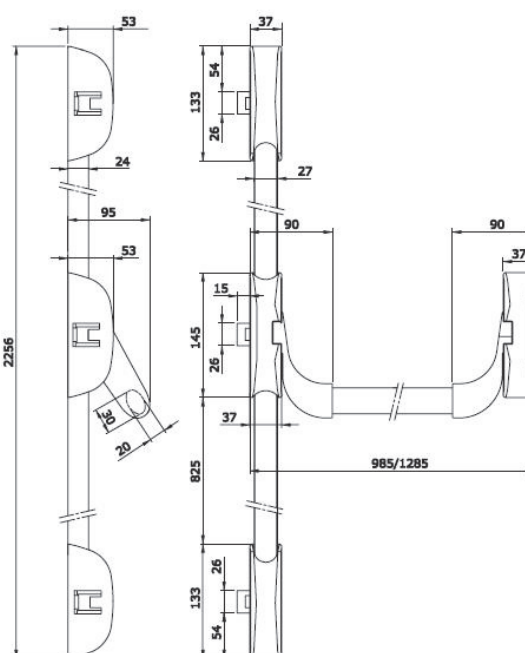

## IDEA BASE –povrchová montáž, modulární provedení

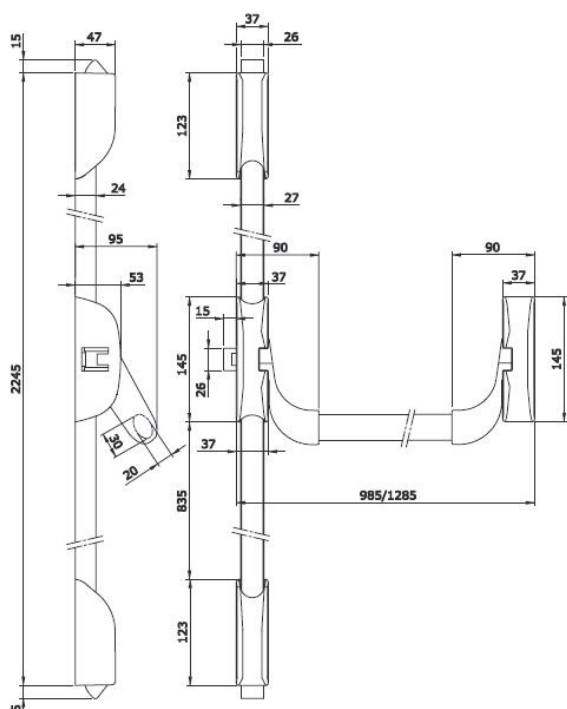
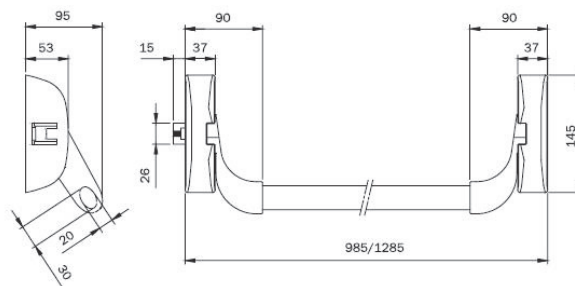

Objednací číslo	Povrchová úprava
9414000304	Šedá
94140004044	Bílá
9414000504	Černá
9414000524	PVD, nerez

- Snadná instalace, modulární systém
- Pravo – levé provedení
- Esteticky příjemný design
- Zaoblené hrany pro bezpečné užívání
- Pro různé typy dveří dle EN 1125
- Kompatibilní s externími štíty ISEO
- Přestavitelné na 2nebo 3bodové zajištění
- Samozamykací střílky
- Balení obsahuje:
  - Sada mechanismů a pák
  - Spojovací materiál
  - Šablony a montážní návod

## IDEA BASE – povrchová montáž, modulární provedení, příslušenství

### Sada západek vertikální

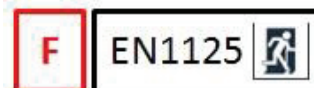

Objednáací číslo	Povrchová úprava
9410201304	Šedá
9410201404	Bílá
9410201504	Černá
9410201524	PVD, nerez

### Sada západek horizontální

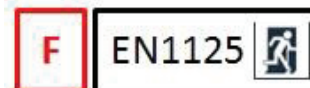
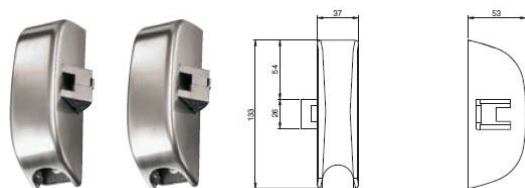

Objednáací číslo	Povrchová úprava
9410203304	Šedá
9410203404	Bílá
9410203504	Černá
9410203524	PVD, nerez

### Sada západek vertikální + horizontální

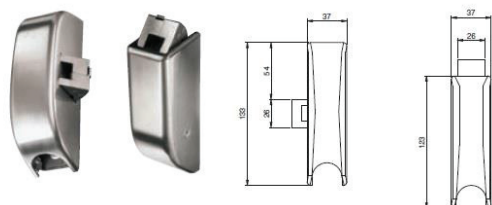

Objednáací číslo	Povrchová úprava
9410204304	Šedá
9410204404	Bílá
9410204504	Černá
9410204524	PVD, nerez

## IDEA BASE – povrchová montáž, modulární provedení, příslušenství

### Rozvorové tyče a kryty

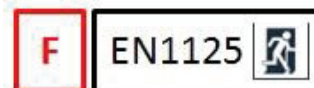

Délka	Objednací číslo	Povrchová úprava
Max do 2400 mm	94100203	Šedá
	94100204	Bílá
	94100205	Černá
	94100202	PVD, nerez
Max do 3400 mm	94100303	Šedá
	94100304	Bílá
	94100305	Černá
	94100302	PVD, nerez

### Horizontální tyč

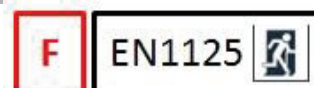
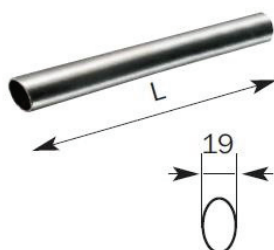

Délka	Objednací číslo	Povrchová úprava
Délka 1130 mm	945923	Šedá
	945924	Bílá
	945925	Černá
	945922	PVD, nerez
	945928	Červená
	945929	Zelená
Délka 1330 mm	945932	PVD, nerez
	945938	červená

# IDEA BASE – aplikační schéma pro použití protiplechů

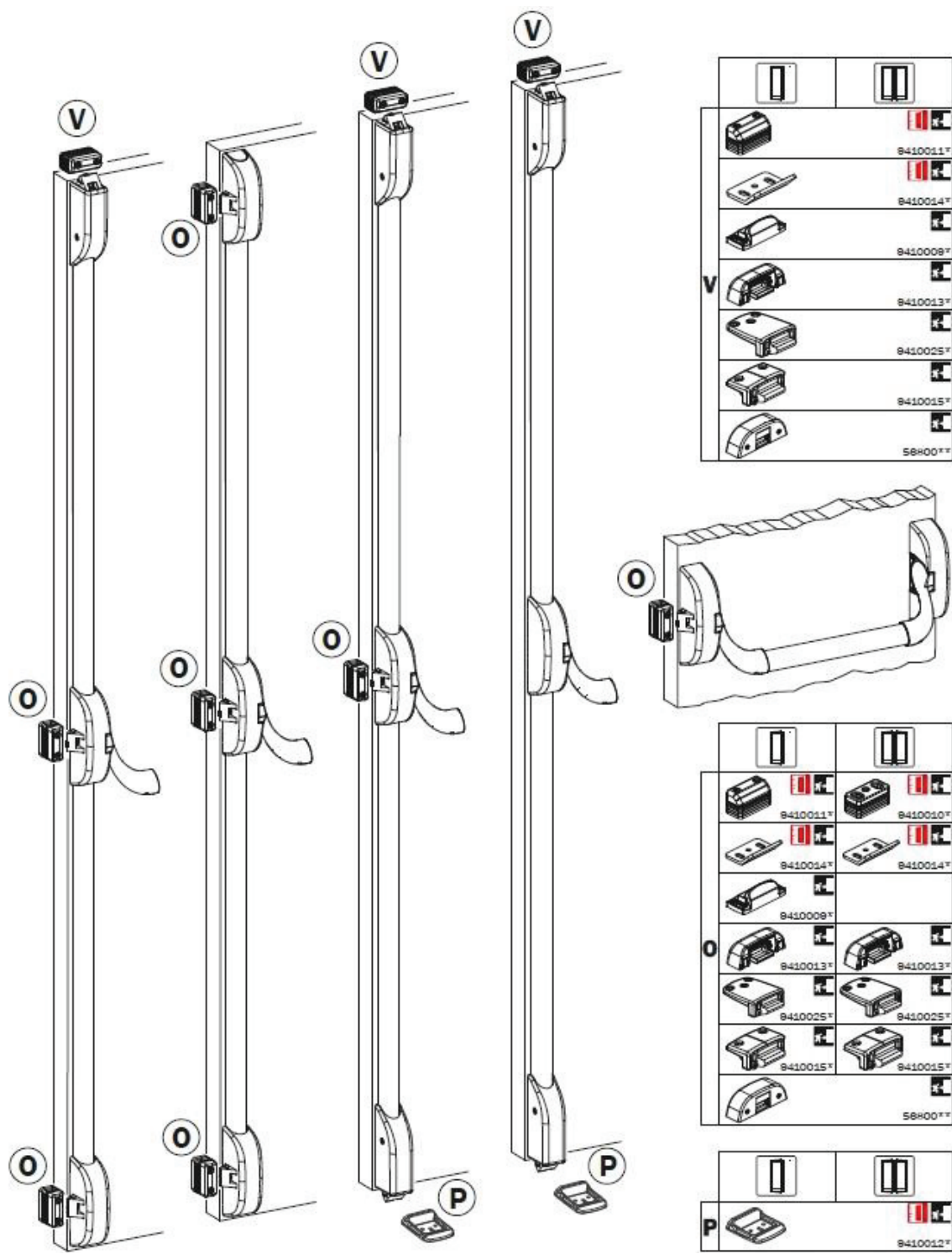

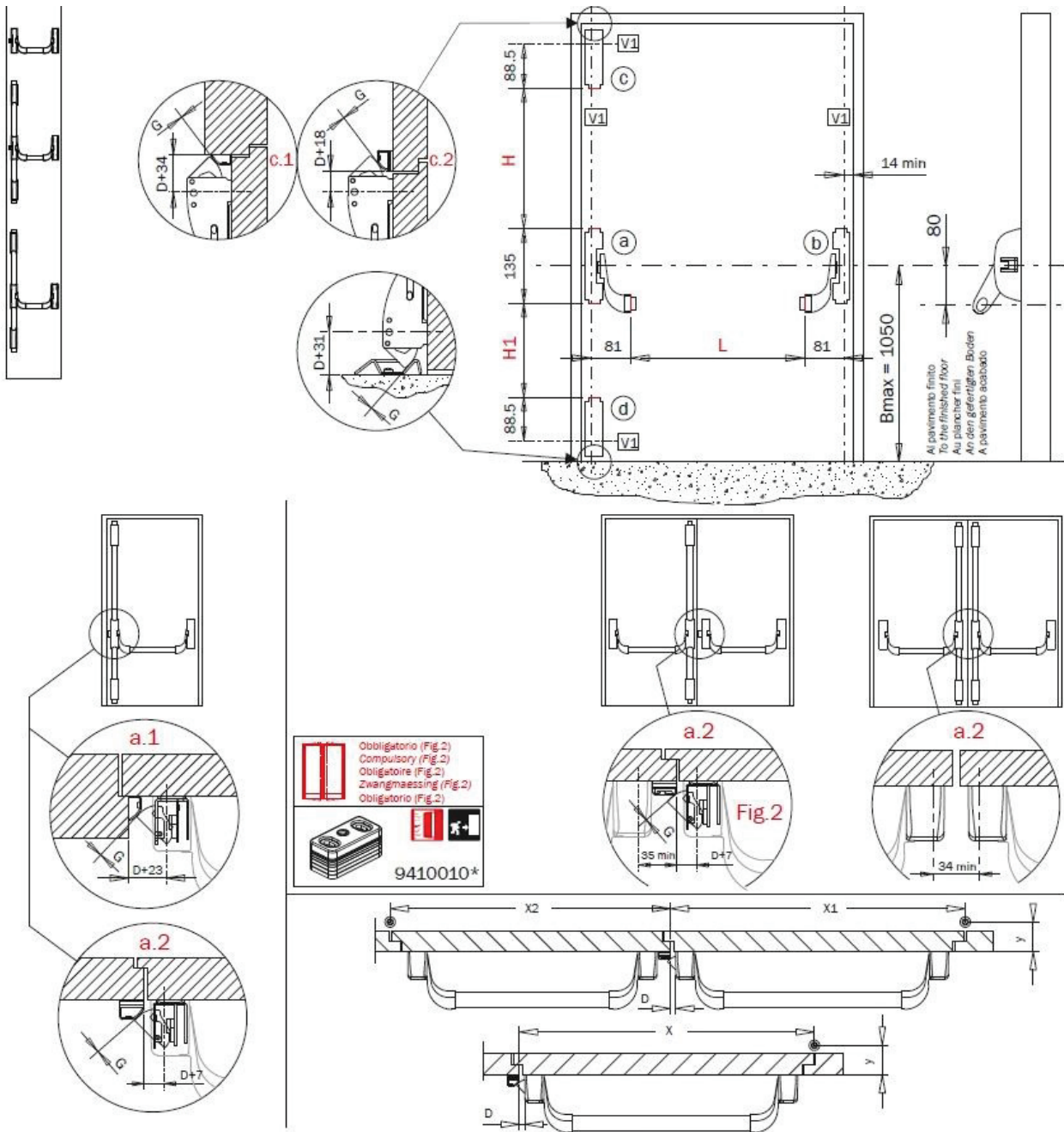

# IDEA BASE – aplikační schéma umístění na dveřích



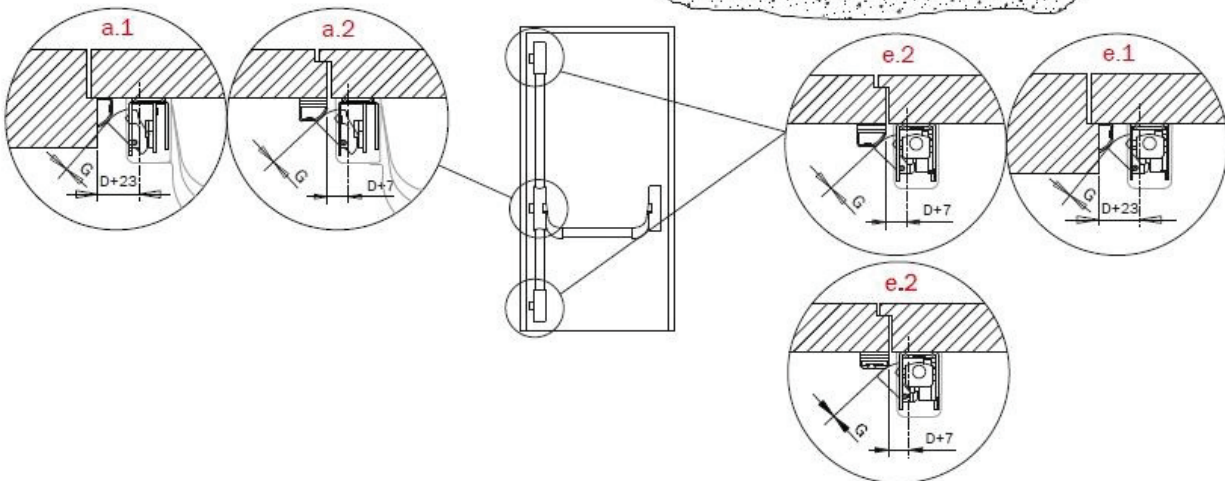
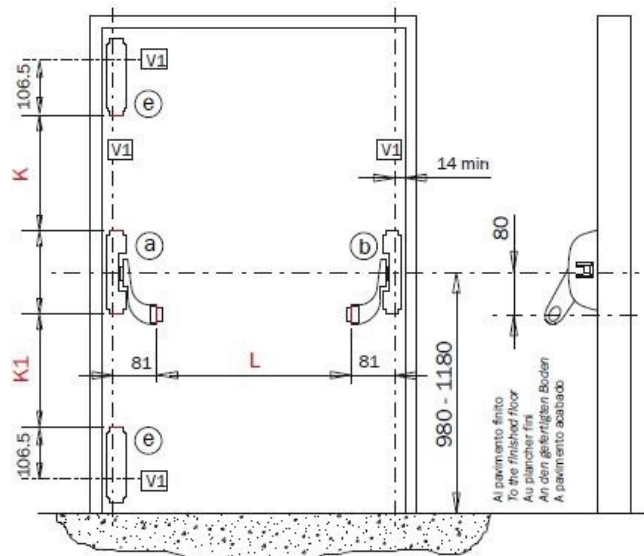
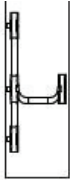

# IDEA BASE – aplikační schéma umístění na dveřích



 Obligatorio (Fig.3-4)  
 Compulsory (Fig.3-4)  
 Obligatoire (Fig.3-4)  
 Zwangsmässig (Fig.3-4)  
 Obligatorio (Fig.3-4)

 **9410010\***

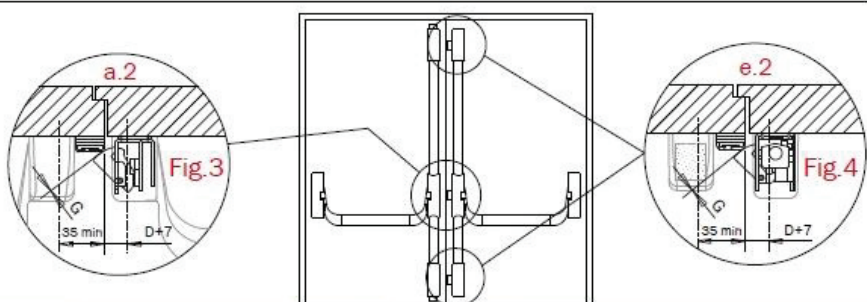

## IDEA BASE – příklady uchycení na dveře

### Samořezné vruty

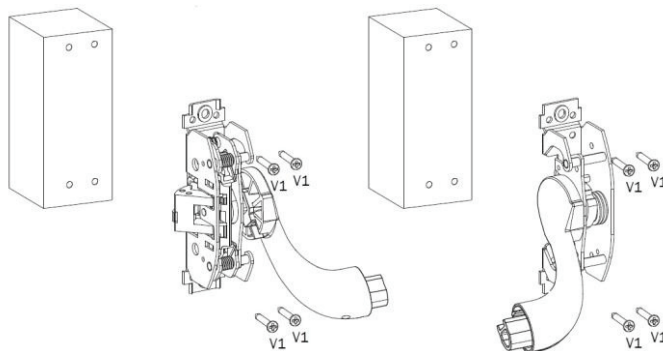
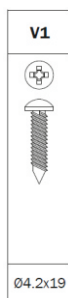

### Nýty

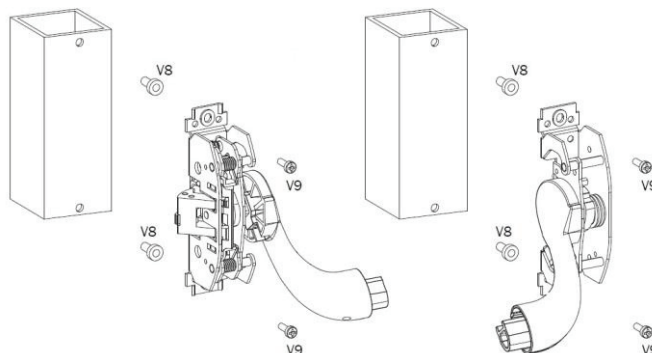
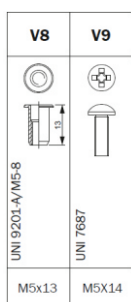

### Pomocí přišroubované/navážené montážní desky

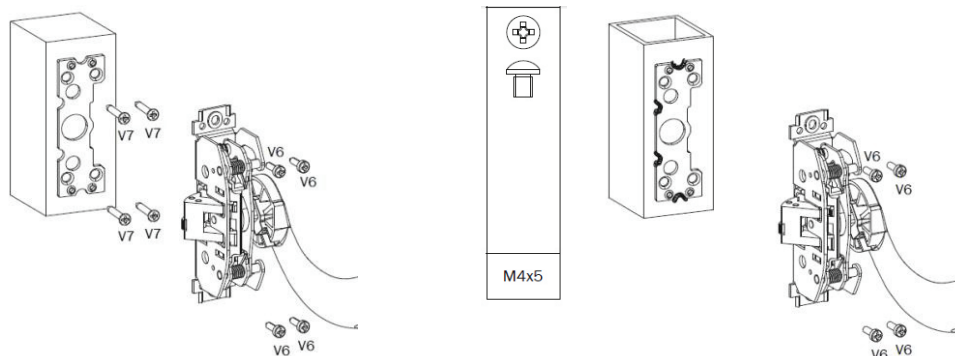
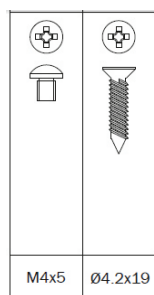



## IDEA BASE – přeměna var. P/L

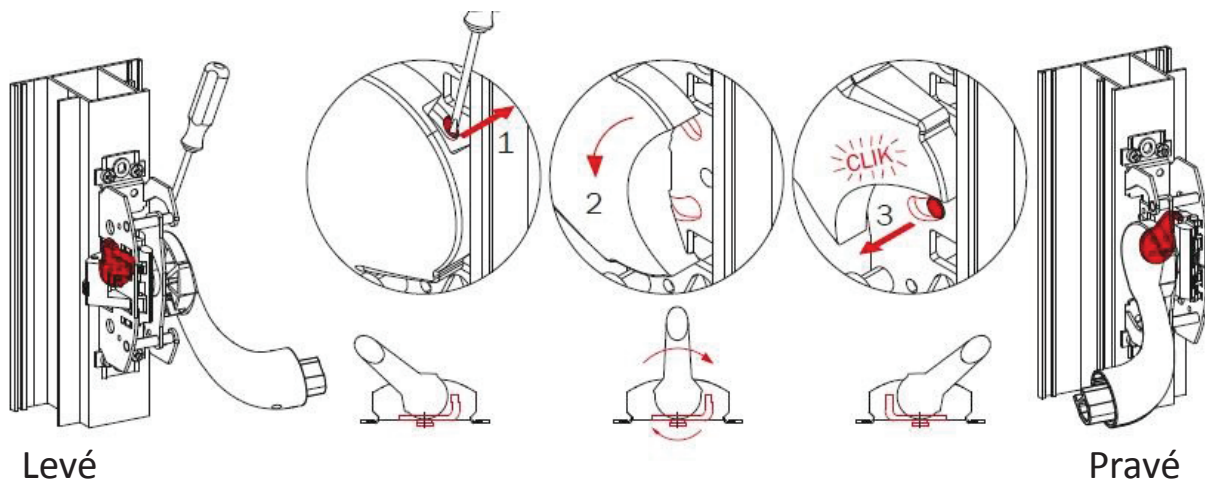



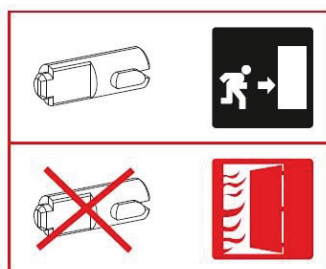
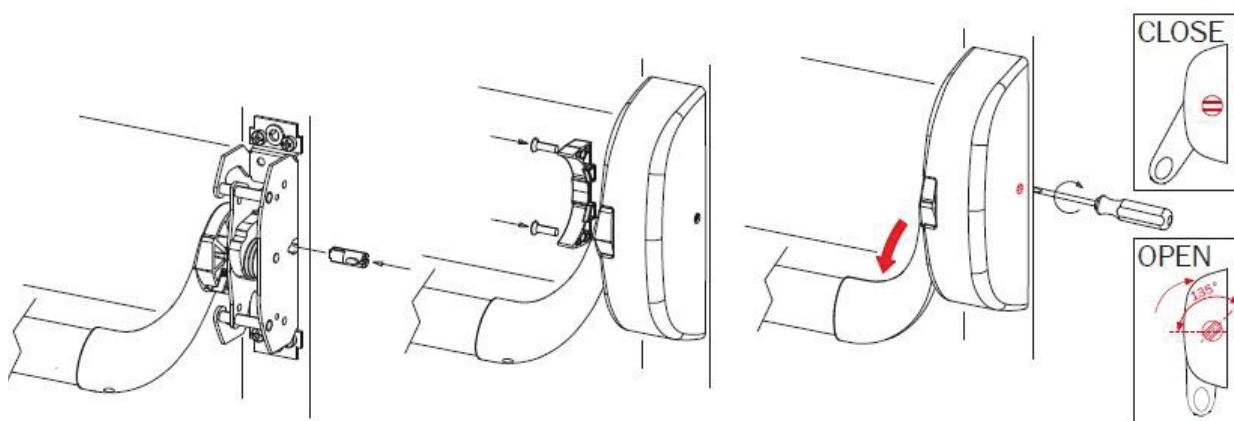





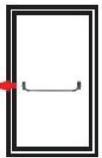
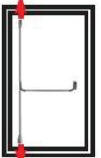
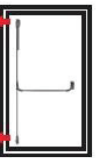

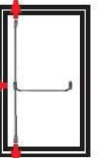
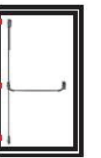
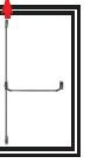



## IDEA BASE – doplňkové zařízení pro trvale stlačené madlo



**Upozornění: nelze použít na požární dveře!!!**

## IDEA BASE – aplikační schéma pro použití na jednokřídlé dveře

							
9414000524 	●	●●	●	●	●	●	●
9410201524 		●			●		
9410204524 				●			●
9410203524 			●			●	
945922 L = 1130 945932 L = 1330 	* ●	* ●●	* ●●	* ●●	* ●●	* ●●	* ●●
94100202 94100302 		* ●	* ●●	* ●●	* ●●	* ●●	* ●●
56800** 5680012 	○		○○	○○		○○○	
94011002T 94021002 	* ○	* ○	* ○	* ○	* ○	* ○	* ○
94012002T 							
94100060 	○	○	○	○	○	○	○
94100070 	○	○	○	○	○	○	○

- = nutné položky (●● = 2bod, ●●● = 3bod)  
 \* = vyberte jednu z variant  
 ○ = volitelné položky (○○ = 2bod, ○○○ = 3bod)

## IDEA BASE – aplikační schéma pro použití na dvoukřídlé dveře

9414000524	● ●	● ●	● ●	● ●
9410201524	●	●	●	● ●
9410204524				
9410203524		●	●	
945922 L = 1130 945932 L = 1330	* ● ●	* ● ●	* ● ●	* ● ●
94100202 94100302	* ●	* ● ●	* ● ●	* ● ●
56800** + 5680012				
94011002T 94021002	* ○	* ○	* ○	* ○
94012002T				
94100060	○ ○	○ ○	○ ○	○ ○
94100070	○ ○	○ ○	○ ○	○ ○

- = nutné položky ( ● ● = 2bod, ● ● ● = 3bod)
- \* = vyberte jednu z variant
- = volitelné položky ( ○ ○ = 2bod, ○ ○ ○ = 3bod)