

Druh č.	1601	1602	1603	1603	1607	1608	1608
d (mm)	2,0	1,7	1,9	2,2	2,3	2,5	2,8
t (mm)	12	12	17	17	17	22	19
Vnější šířka (mm)	10	9	10	10	13	12	15
Zatížení – ocel (N)	150	130	140	190	200	300	360
Zatížení – mosaz (N)	120	80	100	135	135	180	240
Dodáváno v	FE/MS	FE/MS	FE/MS	FE/MS	FE/MS/X	FE/MS	FE/MS
Hmotnost 100 m (kg)	7,0	5,0	6,0	6,0	8,0	9,0	12,0

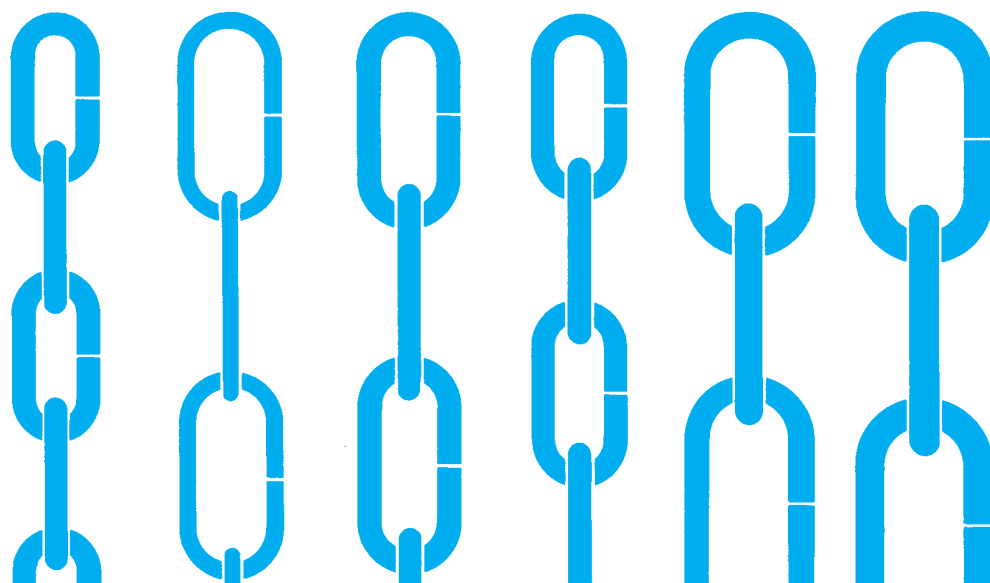

Druh č.	1849	1609	1609	1848	1818
d (mm)	2,8	2,0	3,0	3,1	3,4
t (mm)	18	25	24	20	27
Vnější šířka (mm)	12	14	14	13	18
Zatížení – ocel (N)	380	130	380	410	450
Zatížení – mosaz (N)	260	90	250	280	300
Dodáváno v	FE/MS	FE/MS	FE/MS/X	FE/MS	FE/MS
Hmotnost 100 m (kg)	12,0	6,0	13,0	15,0	18,0

Materiál: FE = ocel, MS = mosaz, X = nerez, CU = měď, AL = hliník, P = plastická hmota

Uvedené zboží je bez atestu.

PÖSAMO - Řetězárna, spol. s r. o., Zahradní 1094, 534 01 Holice, telefon: +420 466 681 228, fax: +420 466 681 229

<http://www.posamo.cz>, e-mail: posamo@holice.cz

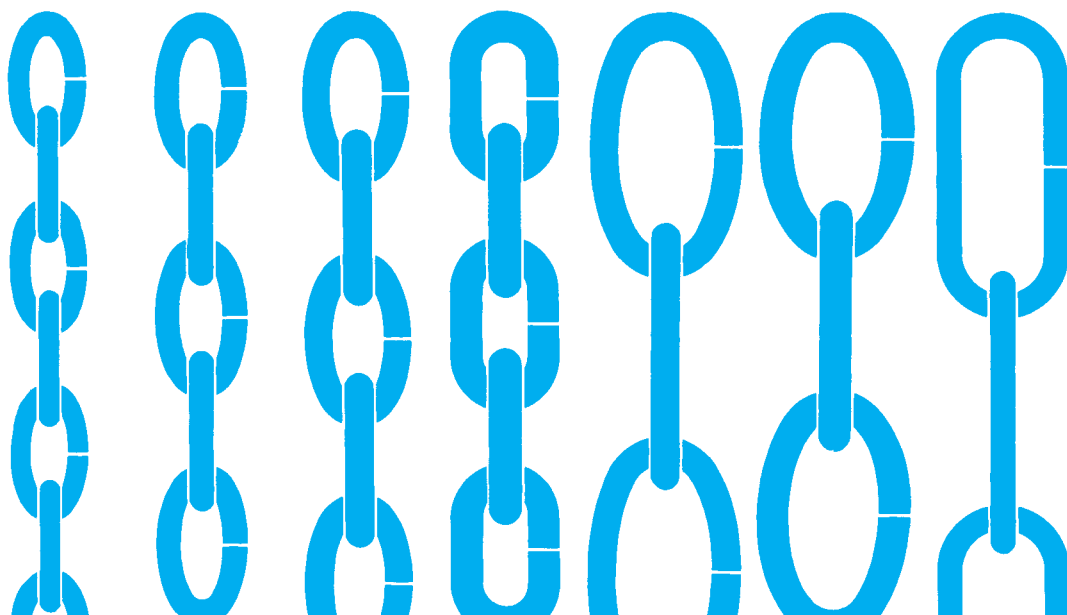
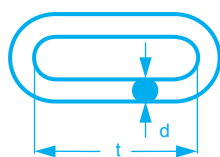

Druh č.	1604	1604	1605	1605	1619	1618	1613
d (mm)	2,65	3,0	3,6	4,0	3,5	3,8	3,0
t (mm)	13	15	16	15	28	25	34
Vnější šířka (mm)	10	12	14	14	20	20	17
Zatížení – ocel (N)	320	380	490	650	400	550	380
Zatížení – mosaz (N)	200	260	300	360	250	280	180
Dodáváno v	FE/MS/X	FE/MS	FE/MS	FE/MS	FE/MS	FE/MS	FE/MS
Hmotnost 100 m (kg)	11,0	14,0	21,0	32,0	18,0	23,0	14,0

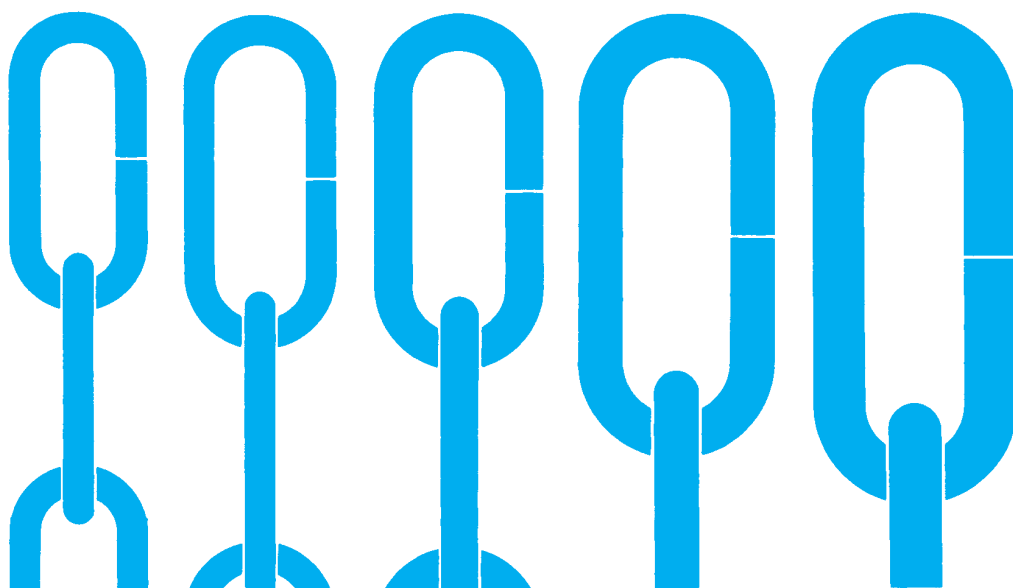

Druh č.	1613	1615	1615	1623	1824
d (mm)	4,0	4,0	5,0	6,0	7,0
t (mm)	34	39	40	50	55
Vnější šířka (mm)	19	21	23	27	28
Zatížení – ocel (N)	650	650	950	1200	1550
Zatížení – mosaz (N)	360	360	450	800	990
Dodáváno v	FE/MS/X	FE/MS	FE/MS	FE/MS	FE/MS/CU
Hmotnost 100 m (kg)	24,0	23,0	35,0	50,0	80,0

Materiál: FE = ocel, MS = mosaz, X = nerez, CU = měď, AL = hliník, P = plastická hmota

Uvedené zboží je bez atestu.

PÖSAMO - Řetězárna, spol. s r. o., Zahradní 1094, 534 01 Holice, telefon: +420 466 681 228, fax: +420 466 681 229

<http://www.posamo.cz>, e-mail: posamo@holice.cz

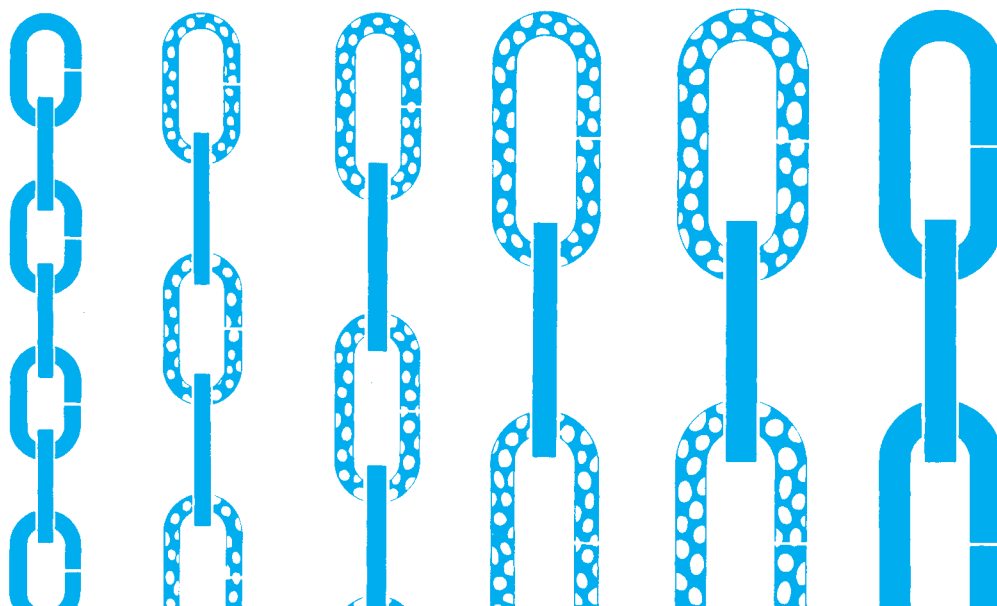
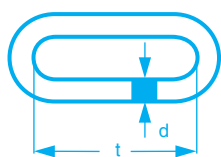

Druh č.	1624K	1625	1627	1629	1631	1630
d (mm)	2,0 x 2,0	2,0 x 2,0	2,3 x 2,3	2,8 x 2,8	4,0 x 4,0	4,0 x 4,0
t (mm)	11	16	20	28	28	28
Vnější šířka (mm)	9	10	11	14	17	16
Zatížení – ocel (N)	120	120	150	190	300	300
Zatížení – mosaz (N)		80		120	200	
Dodáváno v	FE	FE/MS	FE	FE/MS	FE/MS	FE/MS
Hmotnost 100 m (kg)	8,0	8,0	10,0	14,0	31,0	31,0

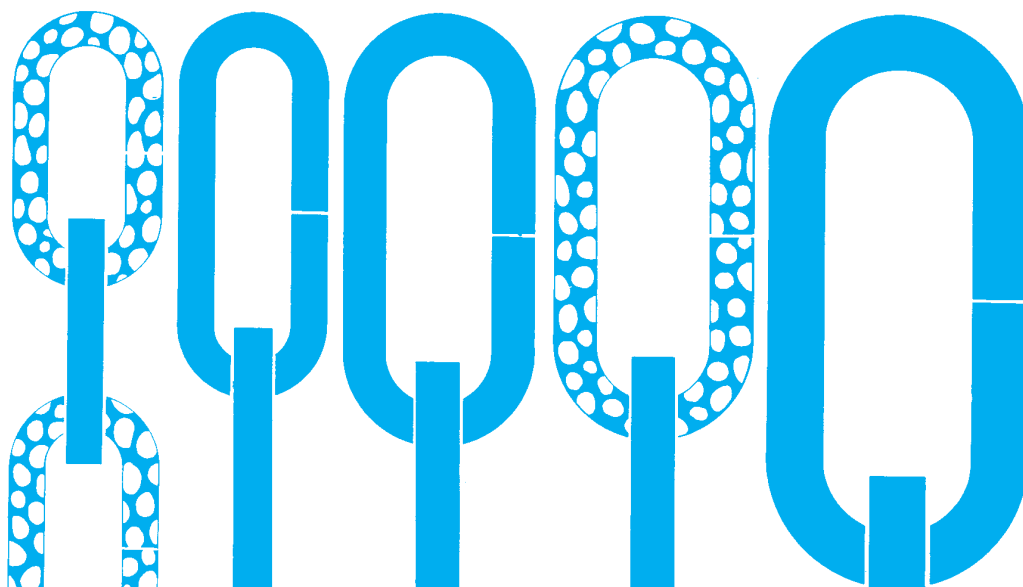

Druh č.	1633	1637	1638	1638G	1852
d (mm)	5,0 x 5,0	5,0 x 5,0	6,0 x 6,0	6,0 x 6,0	8,0 x 8,0
t (mm)	30	45	50	49	66
Vnější šířka (mm)	21	21	27	28	37
Zatížení – ocel (N)	520	520	1450	1450	1850
Zatížení – mosaz (N)	360	360	950		
Dodáváno v	FE/MS	FE	FE/MS	FE	FE
Hmotnost 100 m (kg)	55,0	41,0	60,0	60,0	125,0

Materiál: FE = ocel, MS = mosaz, X = nerez, CU = měď, AL = hliník, P = plastická hmota

Uvedené zboží je bez atestu.

PÖSAMO - Řetězárna, spol. s r. o., Zahradní 1094, 534 01 Holice, telefon: +420 466 681 228, fax: +420 466 681 229

<http://www.posamo.cz>, e-mail: posamo@holice.cz

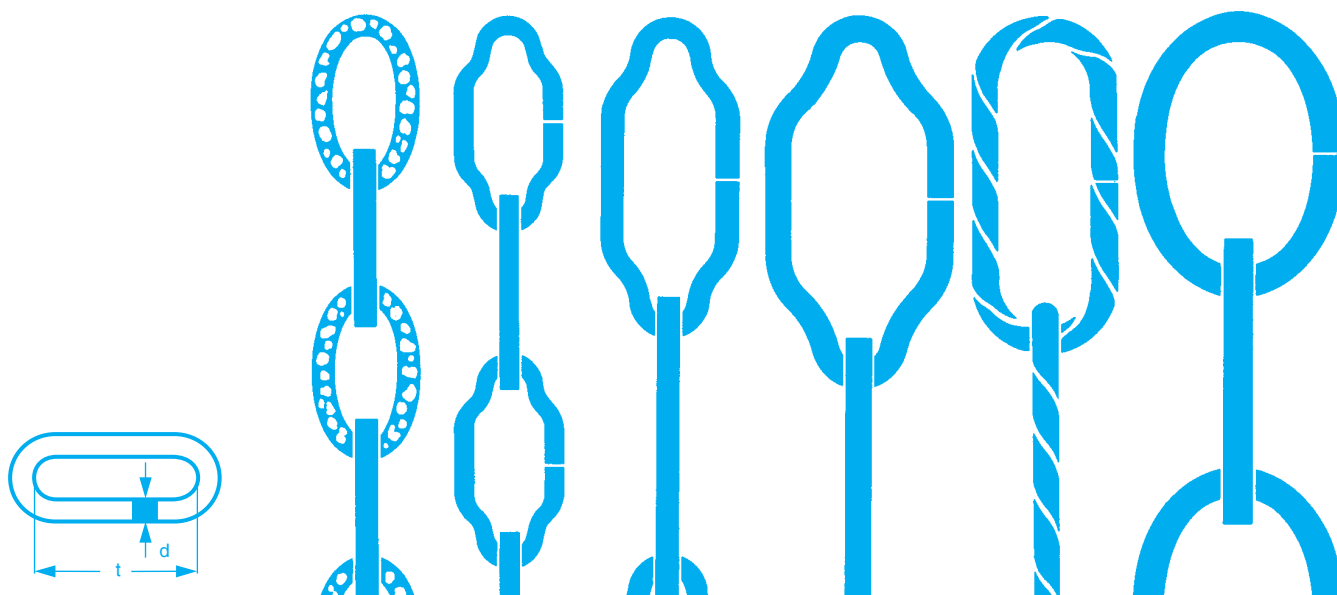

Druh č.	1681	1688	1688	1688	1843	1844
d (mm)	2,8 x 2,8	2,3 x 2,3	2,8 x 2,8	3,5 x 3,5	3,4 x 3,4	4,0 x 4,0
t (mm)	19	25	39	45	40	32
Vnější šířka (mm)	15	15	19	26	20	29
Zatížení – ocel (N)	180	130	180	250	250	300
Zatížení – mosaz (N)						
Dodáváno v	FE	FE	FE	FE	FE	FE
Hmotnost 100 m (kg)	11,0	9,0	12,0	23,0	20,0	30,0

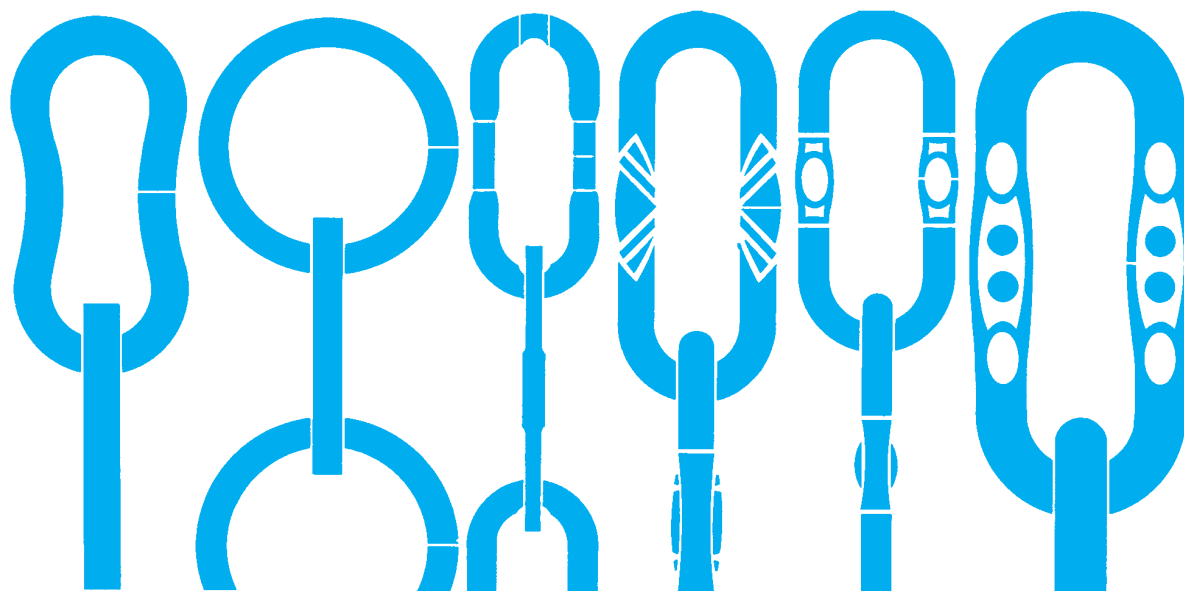

Druh č.	0036	0035	1856	1833	1673	1837
d (mm)	5,0 x 5,0	4,0 x 4,0	3,0	5,0	4,0	7,0
t (mm)	40	28	34	45	40	57
Vnější šířka (mm)	26	36	17	22	21	29
Zatížení – ocel (N)	520	250	175	500	300	
Zatížení – mosaz (N)						800
Dodáváno v	FE	FE	FE	FE/MS	FE/MS	MS
Hmotnost 100 m (kg)	39,0	38,0	13,0	33,0	24,0	65,0

Materiál: FE = ocel, MS = mosaz, X = nerez, CU = měď, AL = hliník, P = plastická hmota

Uvedené zboží je bez atestu.

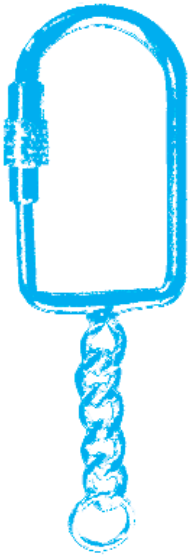

SK900



SK930

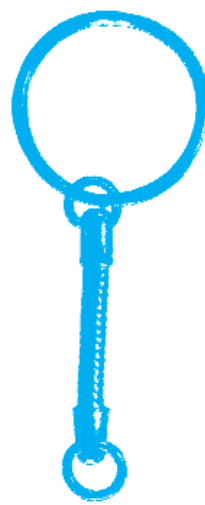

SK931



SK935



SK940



SK945



SK956



SK961



SK962



SK963



SK964



SK965



SK966

Materiál: poniklováno
Uvedené zboží je bez atestu.



SK967



SK968



SK970



SK971



SK972



SK972RS



SK973



SK974RS



SK975



SK980



SK983



SK984



SK990



SK992



SK994

Materiál: poniklováno
Uvedené zboží je bez atestu.

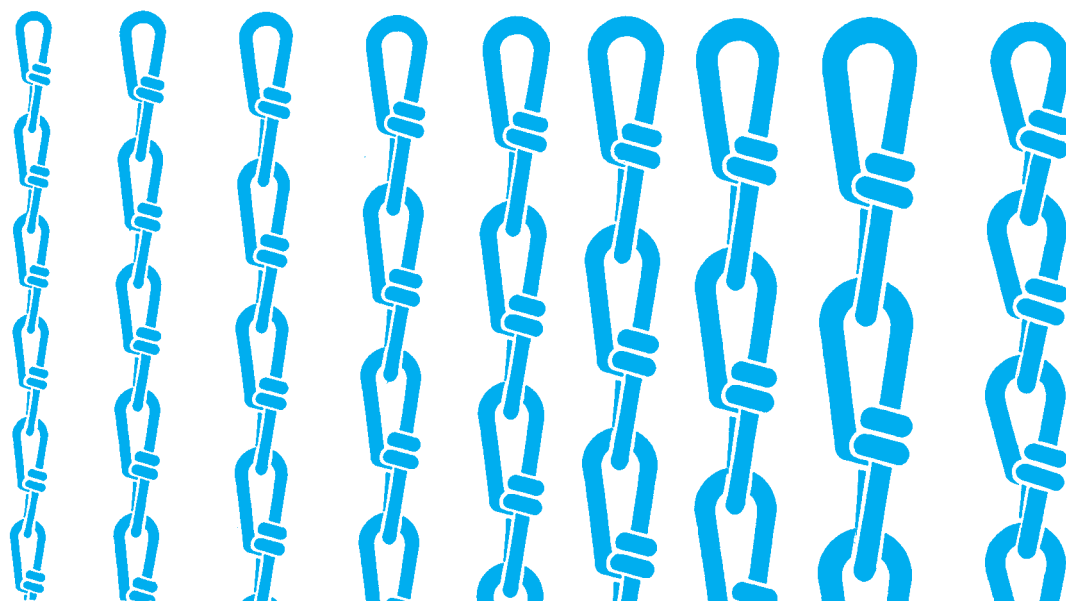
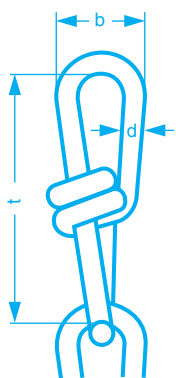

Druh č.	K10	K12	K14	K16	K20	K22	K25	K27	K25K
d (mm)	1,0	1,2	1,4	1,6	1,8	2,0	2,2	2,5	2,2
t (mm)	14	17	20	23	25	28	31	35	22
Vnější šířka (mm)	4,5	5,5	6,5	7,0	8,0	9,0	10,0	11,0	10,0
Zatížení – ocel (N)	300	500	650	880	1500	1750	2100	2800	2100
Zatížení – mosaz (N)									
Dodáváno v	FE/X	FE/MS/X	FE/MS/X	FE/MS/X	FE/MS/X	FE/MS/X	FE/MS/X	FE/MS/X	FE
Hmotnost 100 m (kg)	2,2	3,0	4,2	5,2	6,8	8,4	11,0	13,2	11,0

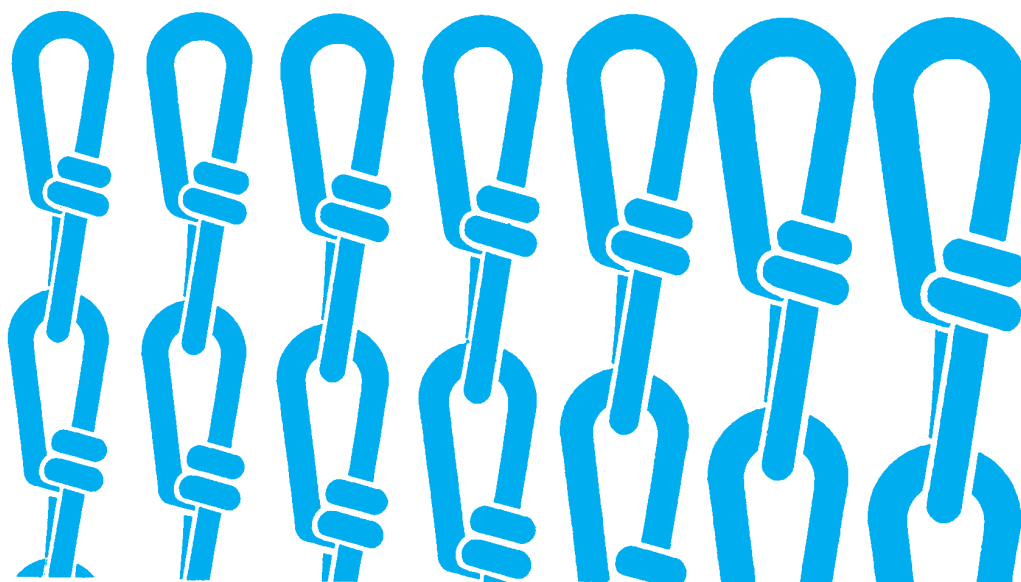

Druh č.	K30	K32	K35	K40	K45	K50	K55
d (mm)	2,8	3,1	3,4	3,8	4,2	4,6	5,0
t (mm)	39	41	44	46	50	55	60
Vnější šířka (mm)	12,5	14,0	15,0	17,0	19,0	20,5	22,5
Zatížení – ocel (N)	3250	4550	5300	5500	6700	7300	9500
Zatížení – mosaz (N)							
Dodáváno v	FE/MS/X	FE/MS/AL	FE	FE	FE	FE	FE
Hmotnost 100 m (kg)	16,8	20,2	25,7	32,3	39,7	47,7	56,7

Materiál: FE = ocel, MS = mosaz, X = nerez, CU = měď, AL = hliník, P = plastická hmota

Uvedené zboží je bez atestu.

PÖSAMO - Řetězárna, spol. s r. o., Zahradní 1094, 534 01 Holice, telefon: +420 466 681 228, fax: +420 466 681 229

<http://www.posamo.cz>, e-mail: posamo@holice.cz

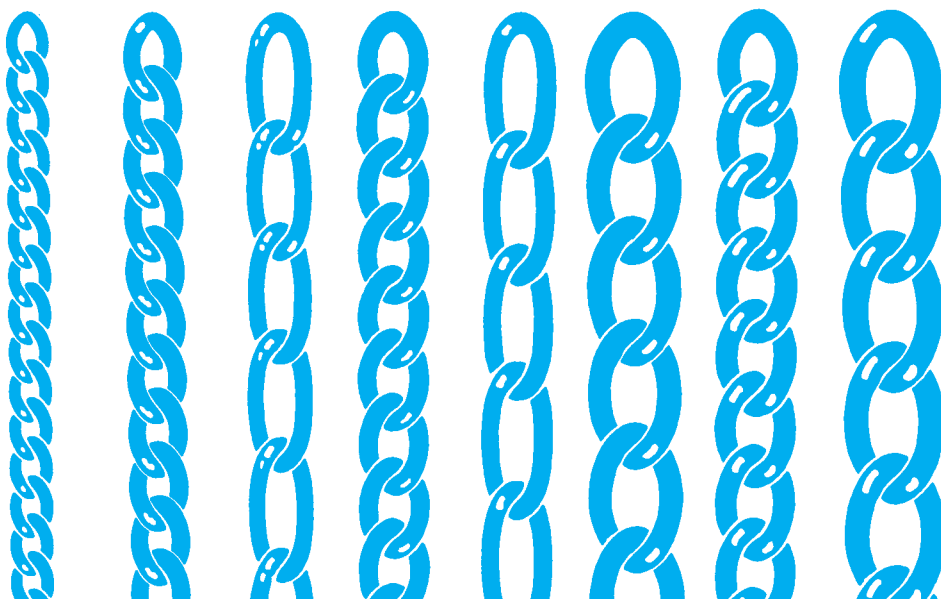
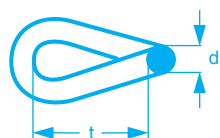

Druh č.	GG150	GG200	GG200lg	GG250	GG250lg	GG300lg	GG340
d (mm)	1,5	2,0	2,0	2,5	2,5	3,0	3,4
t (mm)	4	7	10	8,3	12	14,6	13,9
Vnější šířka (mm)	5,5	7,5	7,5	8,6	8,8	11,2	12,9
Zatížení – ocel (N)	600	1200	1100	1600	1500	3200	4750
Dodáváno v	FE	FE	FE	FE	FE	FE	FE
Hmotnost 100 m (kg)	5,8	8,0	6,7	14,6	11,0	16,8	23,5

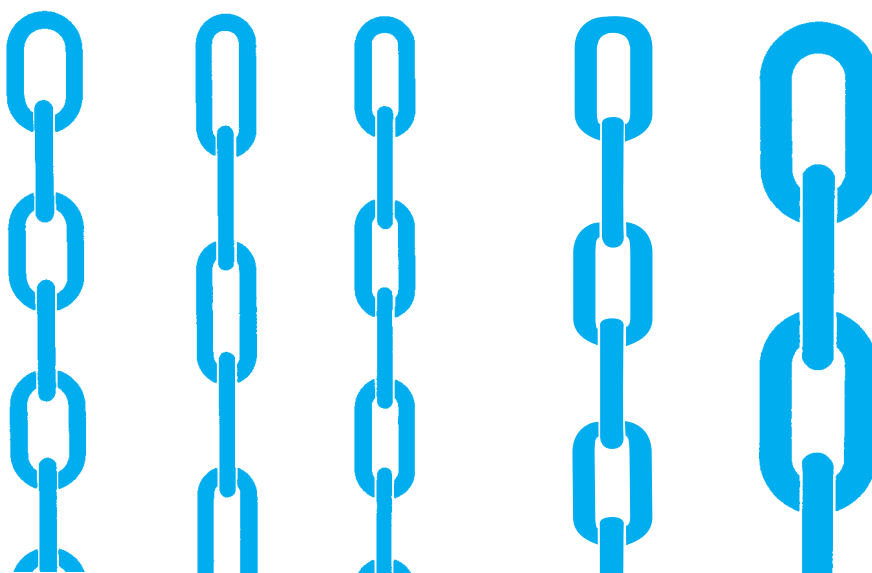

Druh č.	RG1601	19X7	UG168	A25	3x21
d (mm)	2,0	2,0	2	2,5	3,0
t (mm)	12	15,2	12	14	21
Vnější šířka (mm)	9,7	7,4	7,5	10	14
Zatížení – ocel (N)	1000	750	1200		
Zatížení – mosaz (N)					
Dodáváno v	FE	X	FE	FE	FE
Hmotnost 100 m (kg)	7,1	6,5	7,0	12,5	16,6

Materiál: FE = ocel, MS = mosaz, X = nerez, CU = měď, AL = hliník, P = plastická hmota

Uvedené zboží je bez atestu.

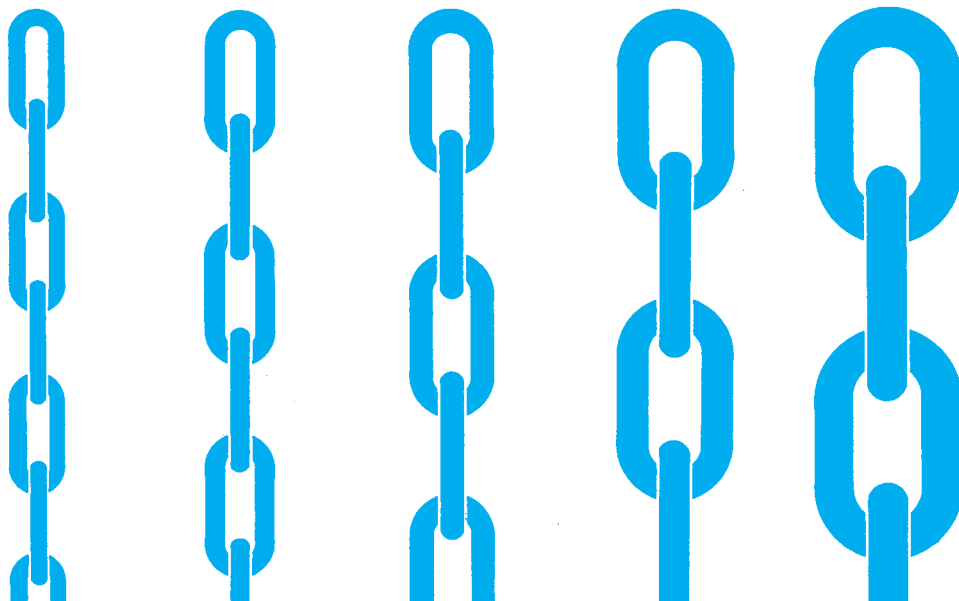
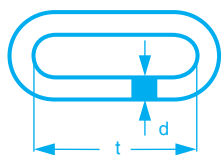

Druh č.	A2	A25	A3	A4	A5
d (mm)	2,0	2,5	3,0	4,0	5,0
t (mm)	12	14	16	19	21
Vnější šířka (mm)	7	9	11	15	19
Zatížení – ocel (N)	1200	2200	3400	6000	9500
Zatížení – mosaz (N)					
Dodáváno v	FE/X	FE	FE/X	FE/MS/X	FE/MS/X
Hmotnost 100 m (kg)	7	11	16,5	30	50

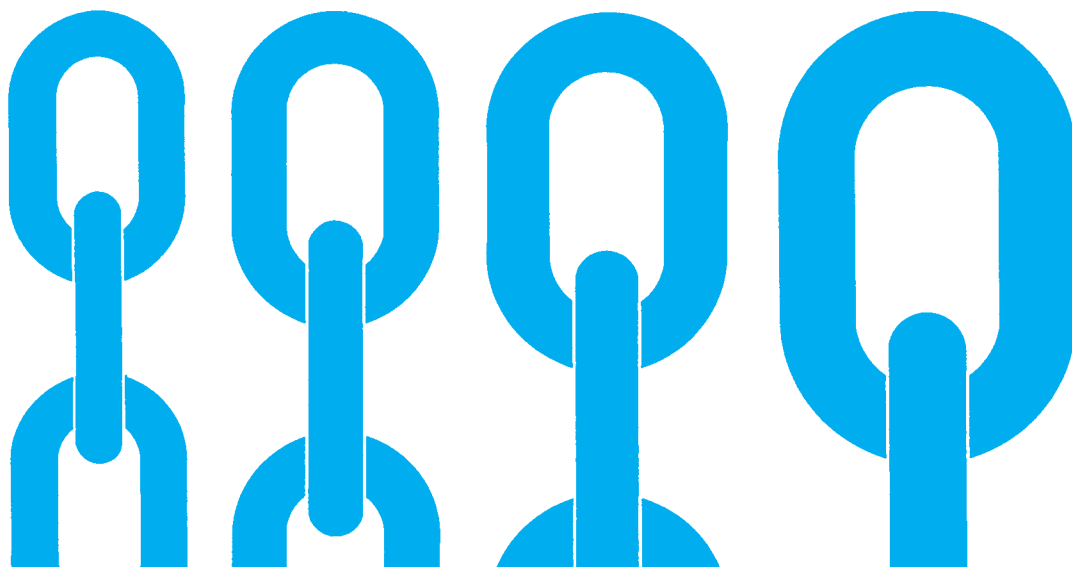

Druh č.	A6	A7	A8	A10
d (mm)	6,0	7,0	8,0	10,0
t (mm)	24	28	32	40
Vnější šířka (mm)	23	27	31	39
Zatížení – ocel (N)	13000	18000	20000	31000
Zatížení – mosaz (N)				
Dodáváno v	FE/MS/X	FE/X	FE/X	FE/X
Hmotnost 100 m (kg)	73	100	130	205

Materiál: FE = ocel, MS = mosaz, X = nerez, CU = měď, AL = hliník, P = plastická hmota

Uvedené zboží je bez atestu.

PÖSAMO - Řetězárna, spol. s r. o., Zahradní 1094, 534 01 Holice, telefon: +420 466 681 228, fax: +420 466 681 229

<http://www.posamo.cz>, e-mail: posamo@holice.cz

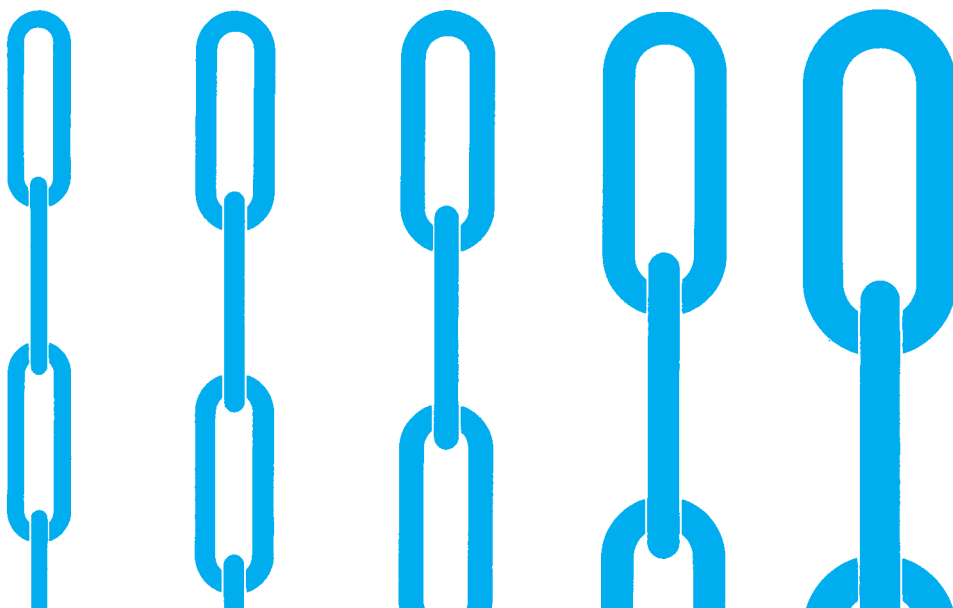
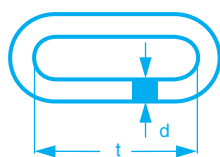

Druh č.	C2	C25	C3	C4	C5
d (mm)	2,0	2,5	3,0	4,0	5,0
t (mm)	22	24	26	32	36
Vnější šířka (mm)	8	10	12	16	20
Zatížení – ocel (N)	1250	2200	3400	5500	8500
Zatížení – mosaz (N)					
Dodáváno v	FE/X	FE	FE/X	FE/X	FE/X
Hmotnost 100 m (kg)	6	10	15	27	43

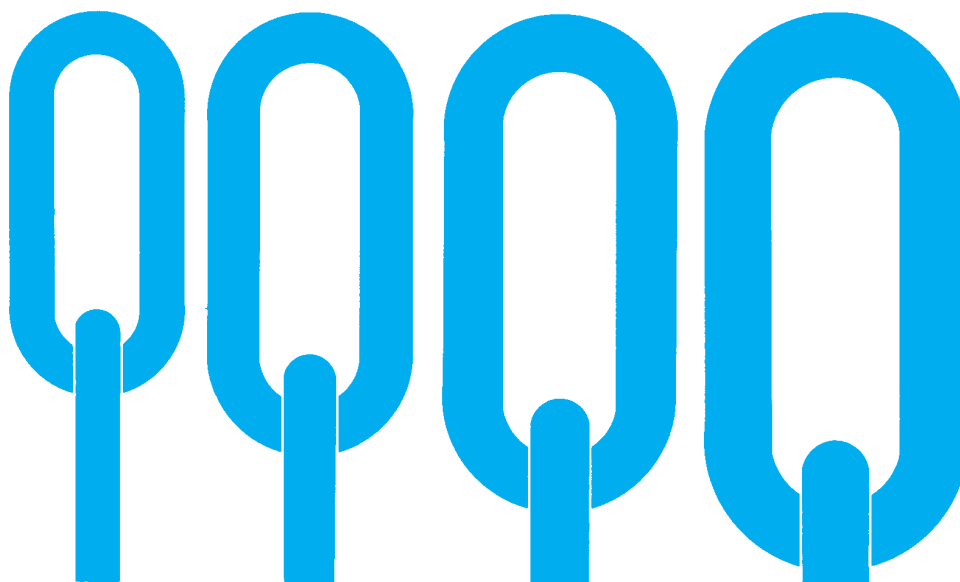

Druh č.	C6	C7	C8	C9	C10
d (mm)	6,0	7,0	8,0	9,0	10,0
t (mm)	42	48	54	60	66
Vnější šířka (mm)	24	28	32	36	40
Zatížení – ocel (N)	12500	17000	22000	28000	31000
Zatížení – mosaz (N)					
Dodáváno v	FE/X	FE/X	FE/X	FE	FE/X
Hmotnost 100 m (kg)	63	85	110	140	175

Materiál: FE = ocel, MS = mosaz, X = nerez, CU = měď, AL = hliník, P = plastická hmota

Uvedené zboží je bez atestu.

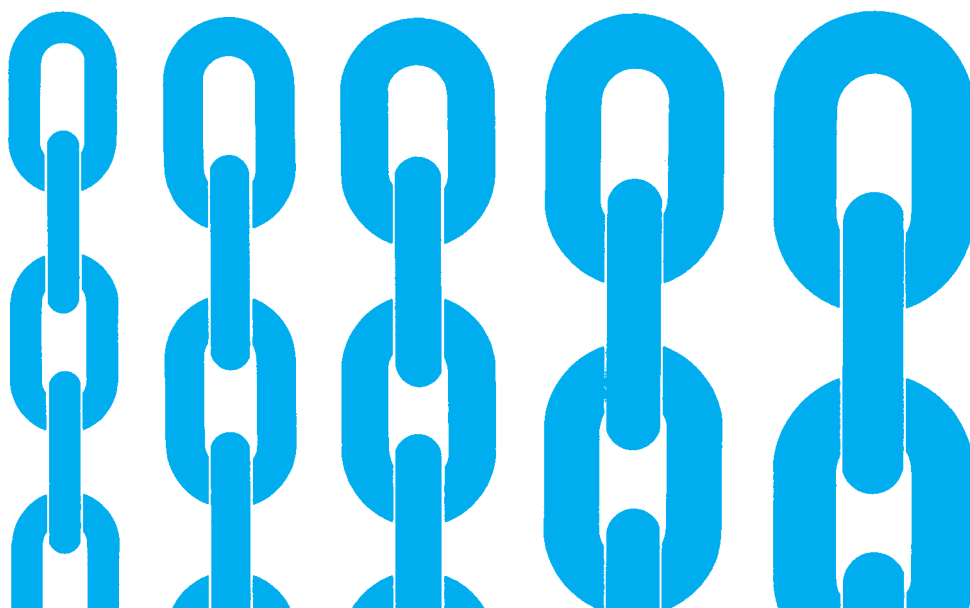
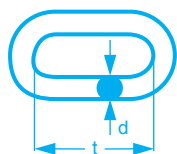

Druh č.	40	50	60	70	80
d (mm)	4,0	5,0	6,0	7,0	8,0
t (mm)	16	18,5	18,5	22	24
Vnější šířka (mm)	14	17	20	23	26
Zatížení – ocel (N)	6000	10000	14000	18000	25000
Dodáváno v	FE/X	FE/X	FE/X	FE	FE/X
Hmotnost 100 m (kg)	32	50	75	100	135

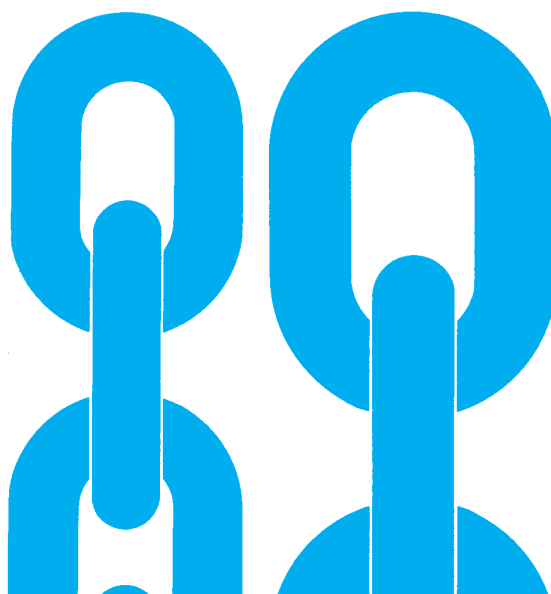
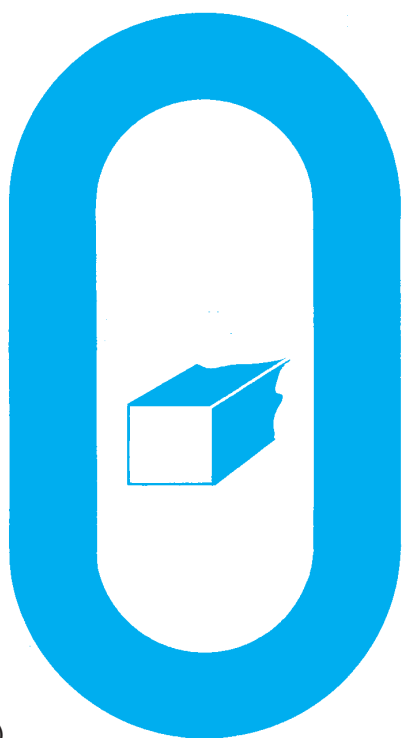

Druh č.	1861	100	120	130
d (mm)	n. 12	10,0	12,0	13,0
t (mm)	85	28	36	36
Vnější šířka (mm)	57	34	42	44
Zatížení – ocel (N)	–	40000	55000	64000
Dodáváno v	FE	FE/X	FE	FE
Hmotnost 100 m (kg)	340 kg	225	350	380

Materiál: FE = ocel, MS = mosaz, X = nerez, CU = měď, AL = hliník, P = plastická hmota

Uvedené zboží je bez atestu.

PÖSAMO - Řetězárna, spol. s r. o., Zahradní 1094, 534 01 Holice, telefon: +420 466 681 228, fax: +420 466 681 229

<http://www.posamo.cz>, e-mail: posamo@holice.cz

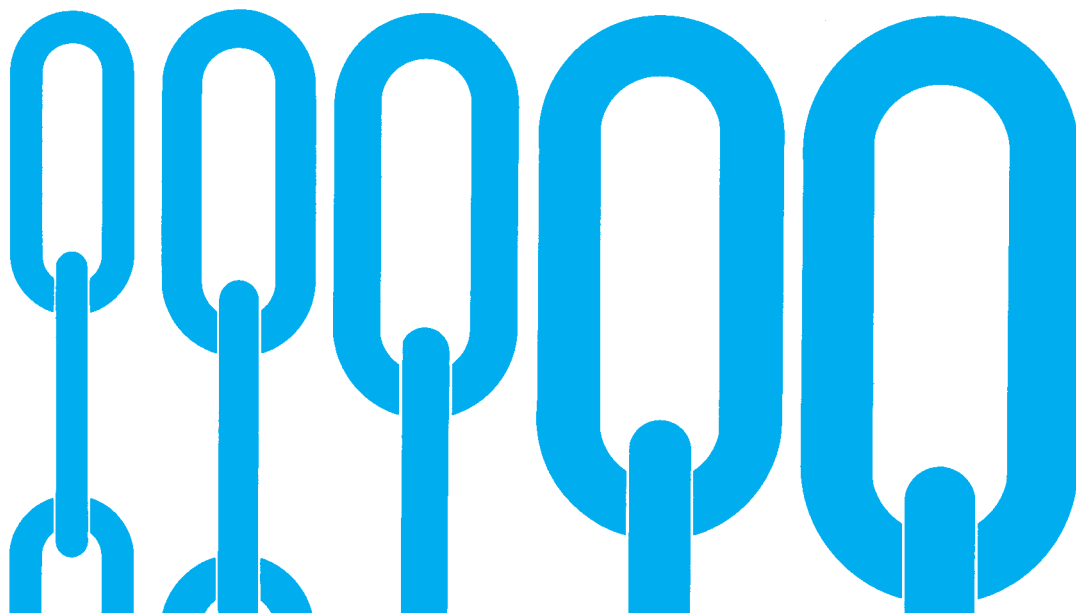
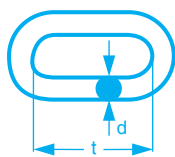

Druh č.	40	50	60	80	100
d (mm)	4,0	5,0	6,0	8,0	10,0
t (mm)	32	36	42	54	66
Vnější šířka (mm)	16	20	24	32	40
Zatížení – ocel (N)	6000	10000	14000	25000	40000
Dodáváno v	FE/X	FE/X	FE/X	FE/X	FE/X
Hmotnost 100 m (kg)	27	43	63	110	175

SVAŘOVANÉ ŘETĚZY TVAR X

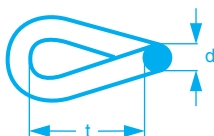

C - dlouhý článek



A - krátký článek



Druh č.	30	40	50	60	70	80	30	40	50	60	70	80
d (mm)	3,0	4,0	5,0	6,0	7,0	8,0	3,0	4,0	5,0	6,0	7,0	8,0
t (mm)	26	32	36	42	48	54	16	19	21	24	28	32
Vnější šířka (mm)	12	16	20	24	28	32	11	15	19	23	27	31
Zatížení – ocel (N)	3400	5500	8500	12500	17000	22000	3400	6000	9500	13000	18000	20000
Dodáváno v	FE	FE	FE	FE	FE	FE	FE	FE	FE	FE	FE	FE
Hmotnost 100 m (kg)	15	27	43	63	85	110	16,5	30	50	73	100	130

Materiál: FE = ocel, MS = mosaz, X = nerez, CU = měď, AL = hliník, P = plastická hmota

Uvedené zboží je bez atestu.

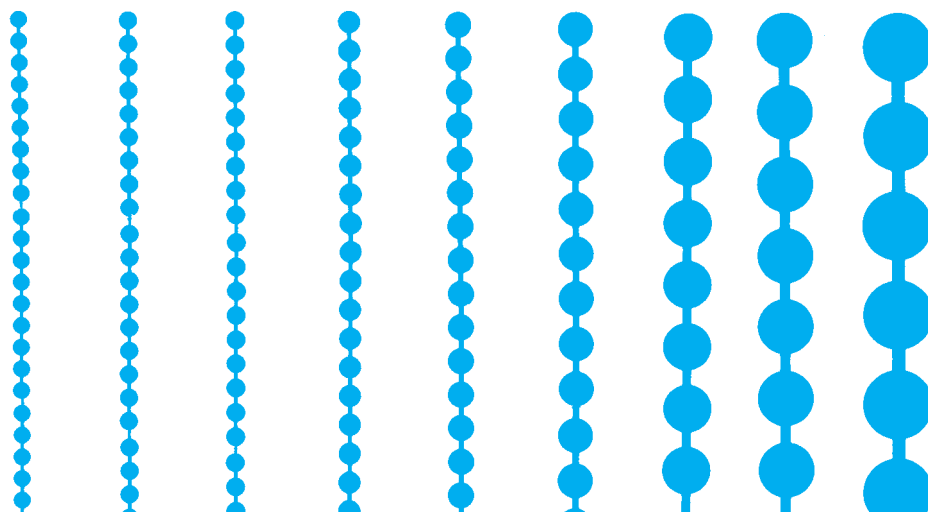
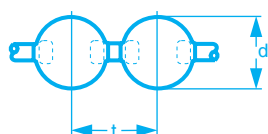

Druh č.	K2	K3	K3	K6	K7	K10	KU6	KU7	KU8
d (mm)	2,1	2,4	2,5	3,2	3,6	4,5	6,0	7,0	8,0
t (mm)	2,6	2,9	3,2	4,0	4,5	5,5	7,6	8,8	9,5
Vnější šířka (mm)	2,1	2,4	2,5	3,2	3,6	4,5	6,0	7,0	8,0
Zatížení – ocel (N)	70	90		130		200	400		
Dodáváno v	FE/MS	FE/MS/X	MS/P	FE/MS/X	MS	FE/MS/X	FE/MS	MS	MS
Hmotnost 100 m (kg)	0,95	1,20	1,50	2,30	2,50	4,20	6,00	8,65	11,50

KULIČKOVÉ ŘETĚZY - KONCOVÉ UZÁVĚRY A PŘÍKLADY MONTÁŽE

Pro kuličkové řetězy	Kotva		Koncovka		Svorka koncová	Svorka s očkem	Zarážka zvonek	Šroubový uzávěr	Volné kuličky
			pevná	vyměnitelná					
d 2,1 2,4 2,5	Nr. 314			Nr. 020	Nr. 89		Nr. 3SL	Nr. 89 ^{1/2}	2,1 MM
d 2,8 3,2 3,6	Nr. 318	Nr. 314	Nr. 6/7	Nr. 019	Nr. 85	Nr. 83	Nr. 6SL	Nr. 85 ^{1/2}	3 MM
d 4,5	Nr. 344	Nr. 311	Nr. 10	Nr. 018	Nr. 81				4 MM
d 6,0				Nr. 017	Nr. 87	Nr. 20A			4,5 MM
d 7,0			Nr. 68	Nr. 016					5 MM
d 8,0									8 MM

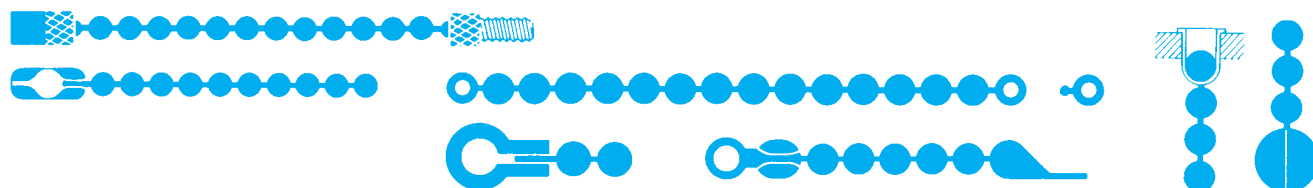

Materiál: FE = ocel, MS = mosaz, X = nerez, CU = měď, AL = hliník, P = plastická hmota

Uvedené zboží je bez atestu.

PÖSAMO - Řetězárna, spol. s r. o., Zahradní 1094, 534 01 Holice, telefon: +420 466 681 228, fax: +420 466 681 229

<http://www.posamo.cz>, e-mail: posamo@holice.cz

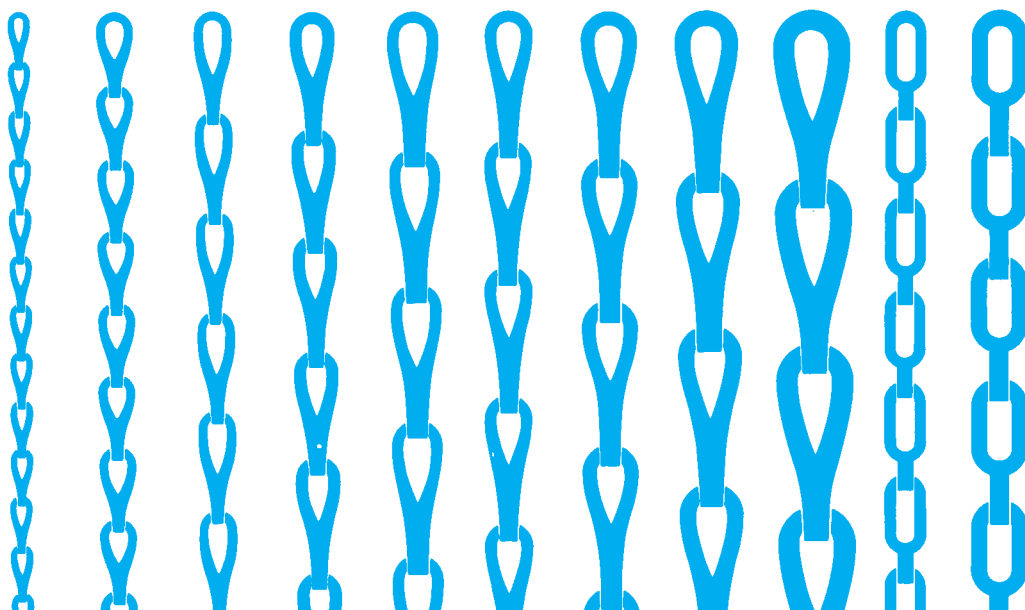
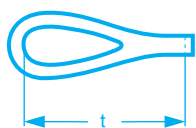

Druh č.	A3/0	130	2	455	555	565	685	6st	7	81/2D	8D
d (mm)	0,3	0,3	0,4	0,5	0,5	0,6	0,8	1,0	1,2	0,4	0,6
t (mm)	5,8	10	14	15	18	17	19	21	22	12	16
Vnější šířka (mm)	2,5	4,5	5	5,5	6,5	6	7	8	9,5	5	7
Zatížení – ocel (N)		230	350	500	550	600	940	1350	1850		850
Zatížení – mosaz (N)	180	210	320	480	530	580	900	1200	1700	380	800
Dodáváno v	MS	FE/MS	FE/MS	FE/MS/X	FE/MS/X	FE/MS/X	FE/MS	FE/MS/X	FE/MS	MS	FE/MS
Hmotnost 100 m (kg)	0,93	–	–	–	–	–	–	–	–	–	–

PŘÍKLADY MONTÁŽE

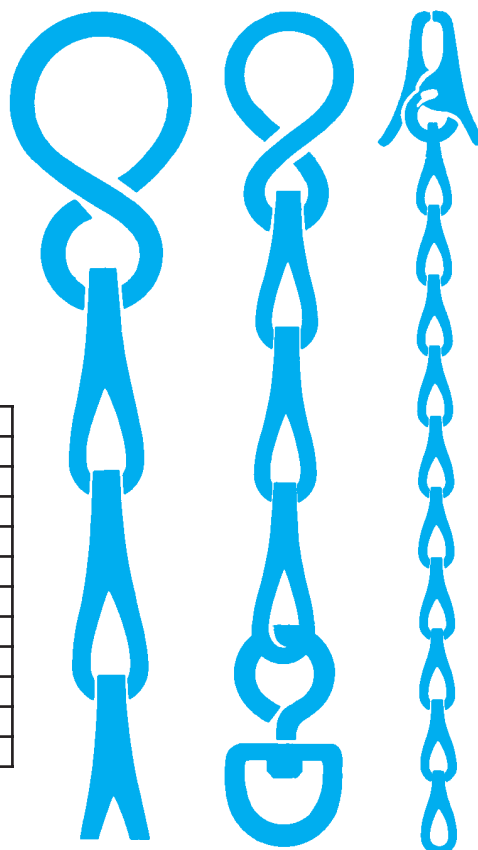
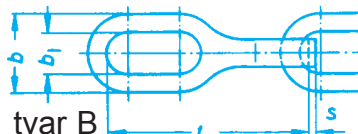
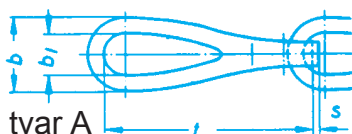

Obj.č.		Síla plechu s	t	b	b ₁	Hmotnost kg/100m	
						Ocel	Mosaz
130	tvar A	0,3	10	4,5	2,4	1,2	1,3
2		0,4	14	5	2,4	1,8	2
455		0,5	15	5,5	2,5	2,6	2,8
555 Lg		0,5	18	6,5	3,5	2,8	3,1
555 K		0,6	17	6	3,2	3,1	3,4
585		0,8	19	7	3,4	4,8	5,3
6 st		1	21	8	4	6,5	7
7	tvar B	1,2	22	9,5	4,2	9,5	10,5
81/2		0,4	12	5	2,4	1,9	2,1
8 D		0,6	16	7	3	3,8	4,1



Pohled ze strany tvar A a tvar B

Materiál: FE = ocel, MS = mosaz, X = nerez, CU = měď, AL = hliník, P = plastická hmota

Uvedené zboží je bez atestu.

PÖSAMO - Řetězárna, spol. s r. o., Zahradní 1094, 534 01 Holice, telefon: +420 466 681 228, fax: +420 466 681 229

<http://www.posamo.cz>, e-mail: posamo@holice.cz

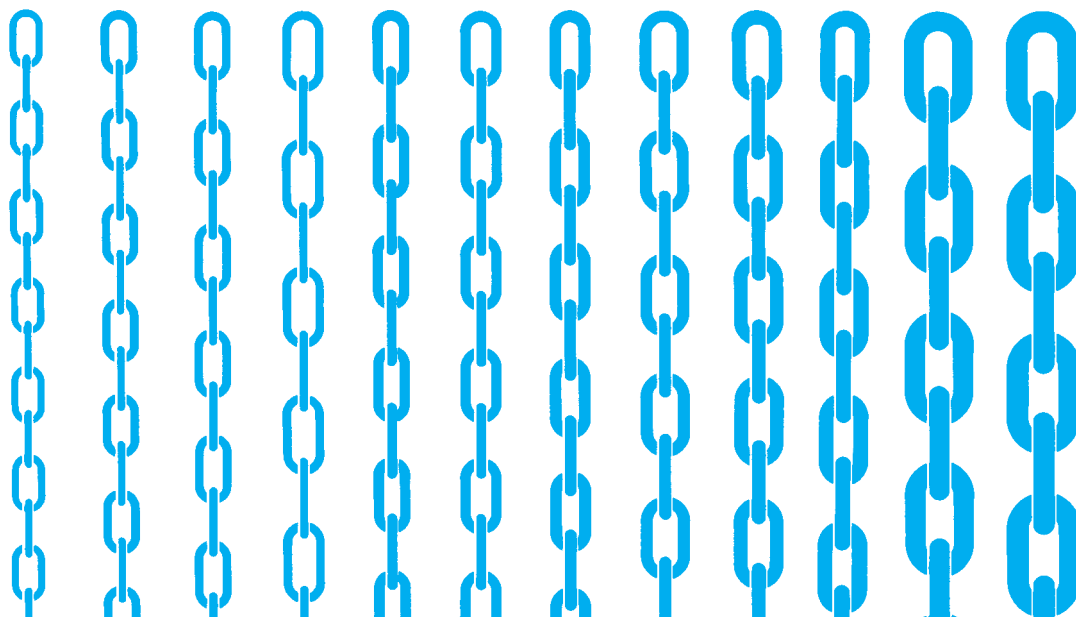
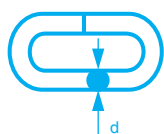

Druh č.	U19	U19	U19	U13	U12	U10	U8	U2	U4	U5	U5 _{1/2}	U250
d (mm)	0,8	0,9	1,0	1,0	1,1	1,2	1,3	1,4	1,6	1,8	2,0	2,5
t (mm)	5,5	6	6,5	8,0	7,0	7,0	7,2	7,5	8,0	8,0	10,0	10,0
Vnější šířka (mm)	4	4,5	4,5	5,0	4,5	5,0	5,0	6,0	6,0	6,0	7,8	9,0
Zatížení – ocel (N)												
Zatížení – mosaz (N)												
Dodáváno v	FE/MS	FE/MS	FE/MS	FE/MS	FE/MS	FE/MS	FE/MS/X	FE/MS/X	FE/MS/X	FE/MS/X	FE/MS/X	FE/MS/X
Hmotnost 100 m (kg)	1,1	1,4	1,7	1,7	1,9	2,6	3,0	3,7	4,7	6,0	7,0	12,0

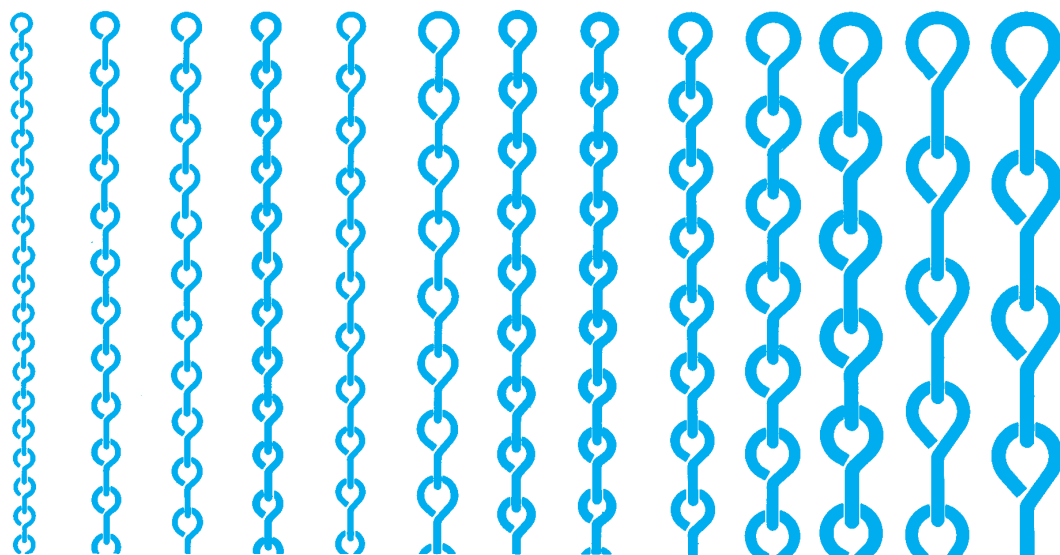

Druh č.	D24	D24	D24	D24	D21	D20	D19	D18	D17	D16	D90	D180L	D180W
d (mm)	0,6	0,7	0,8	1,0	0,8	1,0	1,1	1,3	1,4	1,6	1,8	1,8	2,0
t (mm)	3,9	6,5	7,0	6,5	7,2	9,2	8,5	8,2	10,0	12,2	14,0	18,0	18,6
Vnější šířka (mm)	3,0	3,8	4,2	4,2	4,0	5,5	5,2	5,2	6,5	7,8	8,5	9,0	10,0
Zatížení – ocel (N)											150		
Zatížení – mosaz (N)													
Dodáváno v	FE/MS	FE/MS	FE/MS	FE/MS	FE/MS	FE/MS	FE/MS/X	FE/MS/AL	FE/MS	FE/MS	FE	FE	FE
Hmotnost 100 m (kg)	0,9	1,0	1,2	1,9	1,2	1,5	2,2	3,2	3,7	5,7	6,2	5,4	7,2

Materiál: FE = ocel, MS = mosaz, X = nerez, CU = měď, AL = hliník, P = plastická hmota

Uvedené zboží je bez atestu.

PÖSAMO - Řetězárna, spol. s r. o., Zahradní 1094, 534 01 Holice, telefon: +420 466 681 228, fax: +420 466 681 229

<http://www.posamo.cz>, e-mail: posamo@holice.cz

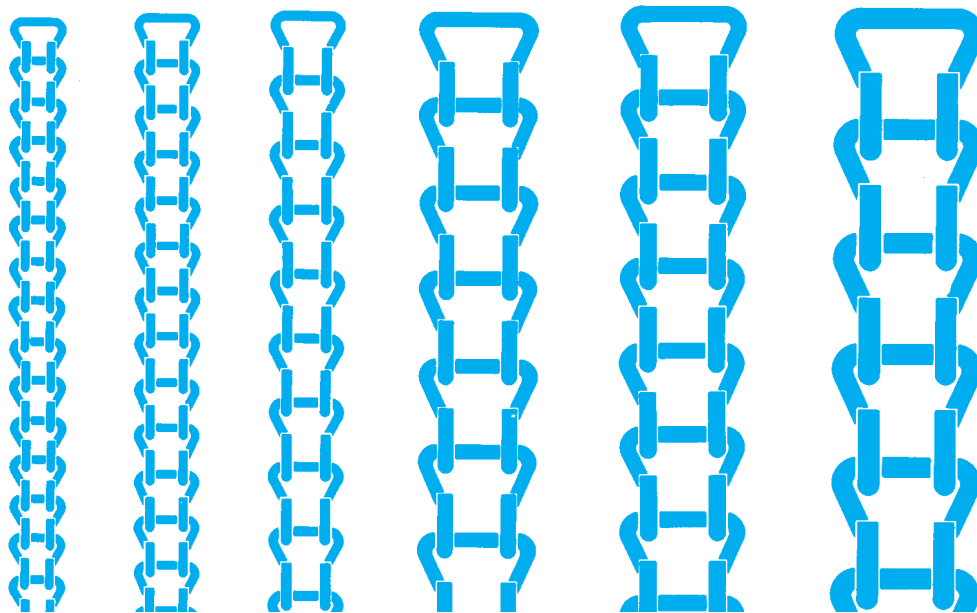
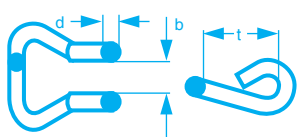

Druh č.	260NK	260	1P	315	330	336
d (mm)	1,0	1,0	1,2	1,8	2,0	2,3
t (mm)						
Vnější šířka (mm)						
Zatížení – ocel (N)	90	90	100	250	270	300
Zatížení – mosaz (N)						
Dodáváno v	FE/MS/X	FE/X	FE/MS/X	FE/MS/X	FE/MS/X	FE/MS/X
Hmotnost 100 m (kg)	3,7	4,0	5,2	10,4	14,1	18,7

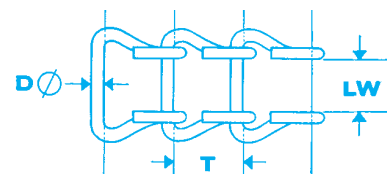
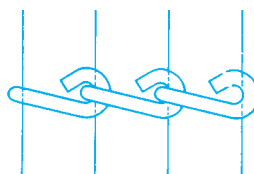
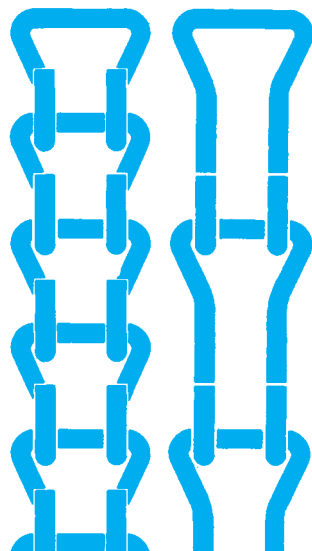
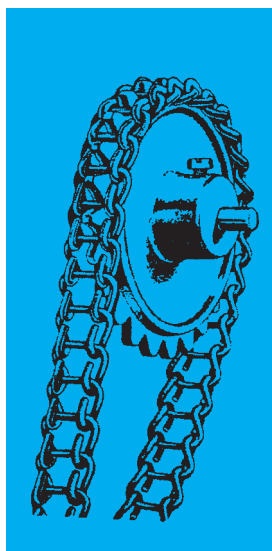

Obj.č.	Síla drátu D	Šířka LW	Rozteč T	Hmotnost 100m (kg)	
				ocel	mosaz
260NK	0,9	2	4,2 - 4,8	2,6	2,8
260NK	1,0	2	4,2 - 4,8	3,4	3,7
260	0,9	3	4,9 - 5,5	2,8	3,0
260	1,0	3	4,9 - 5,5	3,7	4,0
1P	1,2	3,5	6,0 - 8,0	4,7	5,2
315	1,7	5 - 6	9,5 - 10,5	9,5	10,4
330	2,0	6,5	9,5 - 10,5	12,8	14,1
336	2,3	6,5	11,0 - 13,0	17,0	18,7
340	2,4	7	11,0 - 13,0	18,4	20,0

Druh č.	340	200
d (mm)	2,4	2,0
t (mm)		
Vnější šířka (mm)		
Zatížení – ocel (N)		
Zatížení – mosaz (N)		
Dodáváno v	FE/MS	FE/X
Hmotnost 100 m (kg)	20,0	9,6

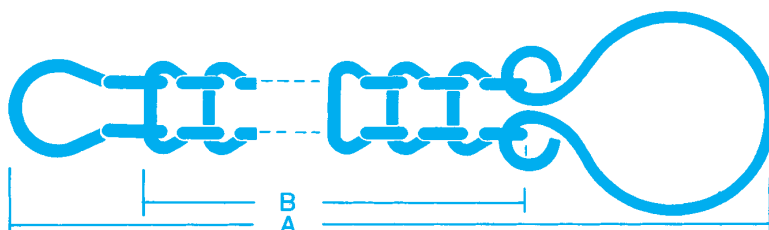

Materiál: FE = ocel, MS = mosaz, X = nerez, CU = měď, AL = hliník, P = plastická hmota

Uvedené zboží je bez atestu.

PÖSAMO - Řetězárna, spol. s r. o., Zahradní 1094, 534 01 Holice, telefon: +420 466 681 228, fax: +420 466 681 229

<http://www.posamo.cz>, e-mail: posamo@holice.cz

PG (broušené)

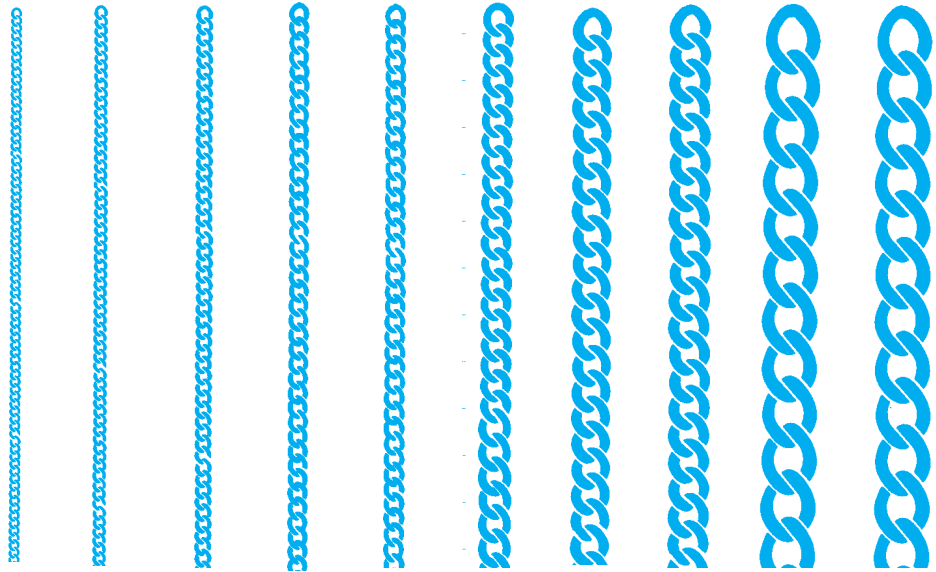
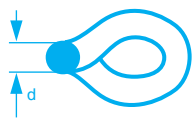

Druh č.	G50	G60	G80	G90	G100	G120	G130	G150	G170	G200
d (mm)	0,5	0,6	0,8	0,9	1,0	1,2	1,3	1,5	1,7	2,0
Dodáváno v	FE/MS	FE/MS/	FE/MS/	FE/MS/	FE/MS/	FE/MS/	FE/MS/	FE/MS/	FE/MS/	FE/MS/
			X/AL		X/AL	X/AL		X/AL	AL	AL
Hmotnost 100 m (kg)	0,5	1,1	1,9	2,0	3,3	3,5	4,0	5,9	8,3	9,4

FG (válcované)

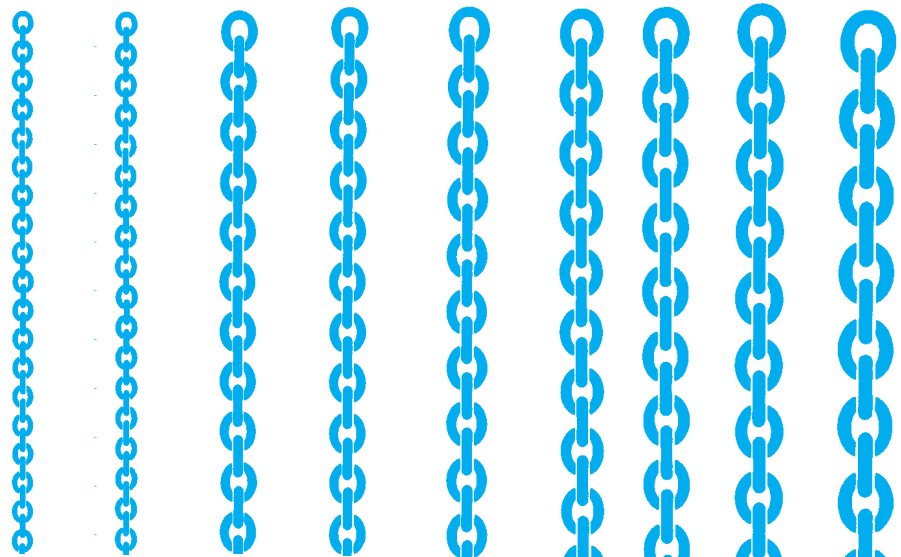
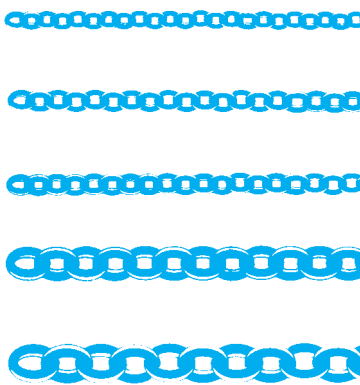

Druh č.	F50	F60	F80	F90	F100	F120	F130	F150	F170
d (mm)	0,5	0,6	0,8	0,9	1,0	1,2	1,3	1,5	1,7
Dodáváno v	FE/MS	FE/MS/AL	FE/MS/AL	FE/MS	FE/MS/AL	FE/S/AL	FE/MS	FE/MS/AL	FE/MS
Hmotnost 100 m (kg)	0,57	0,95	1,5	2,0	2,3	3,3	4,5	5,5	7,9

Materiál: FE = ocel, MS = mosaz, X = nerez, CU = měď, AL = hliník, P = plastická hmota

Uvedené zboží je bez atestu.

PÖSAMO - Řetězárna, spol. s r. o., Zahradní 1094, 534 01 Holice, telefon: +420 466 681 228, fax: +420 466 681 229

<http://www.posamo.cz>, e-mail: posamo@holice.cz

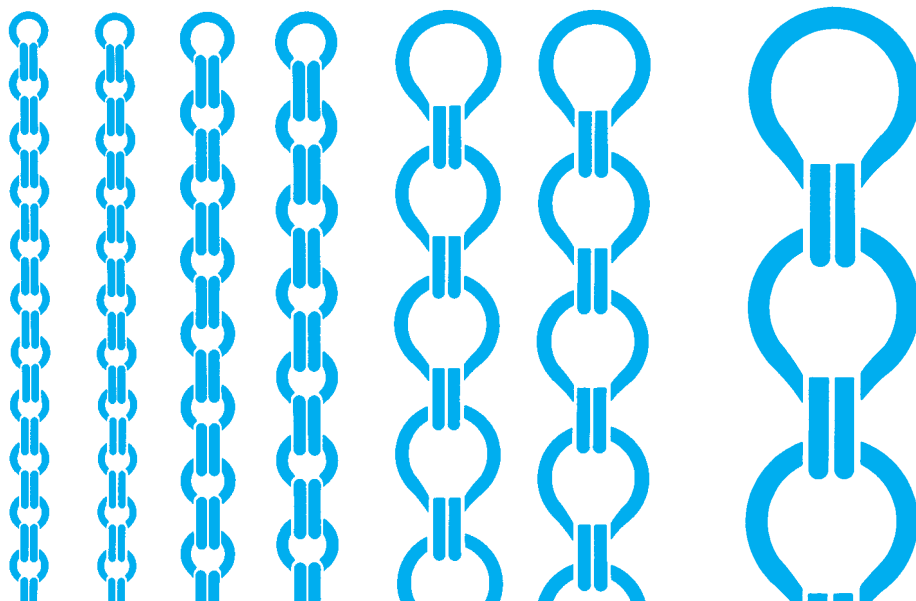
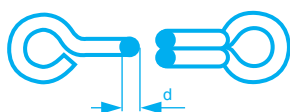

Druh č.	151	152	153	153	12G	12G5	3524R
d (mm)	1,0	1,1	1,2	1,3	1,5	1,8	3,1
t (mm)	8	7	12,0	12,5	20	20	29
Vnější šířka (mm)	5	5	8	7,5	14	14,5	24
Dodáváno v	FE/MS	FE/MS	FE/MS	FE/ms	FE/MS	FE/MS/AL	FE
Hmotnost 100 m (kg)	2,9	3,5	3,8	4,5	5,6	8,0	23,6

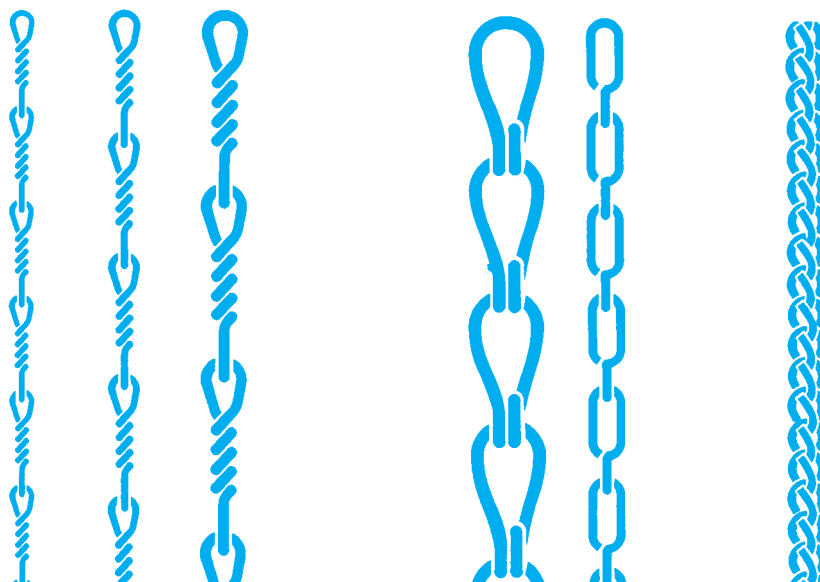

Druh č.	W70	W90	W120	V200	D2EIG	C2
d (mm)	0,7	0,9	1,2	1,8	1,4	1,2
t (mm)	14	18	27	15	15,5	8,0
Vnější šířka (mm)	3,5	4,5	6	10	5	5
Dodáváno v	FE/MS	FE/MS/XFE/MS/X		FE	FE/MS	FE/MS
Hmotnost 100 m (kg)	1,0	1,7	2,8	7,7	3,4	3,0

Materiál: FE = ocel, MS = mosaz, X = nerez, CU = měď, AL = hliník, P = plastická hmota

Uvedené zboží je bez atestu.



Druh č.	SP7	SP9	SP11	SP13	SP18	SP16ST	SP16
d (mm)	0,9	1,0	1,1	1,3	1,3	1,7	1,5
d1 x AB (mm)	7,3x9	10,3x12,5	11,4x14	13x16,5	15,5x18,5	16x20	17x21
Dodáváno v	FE/MS/X/FEG	FE/MS/X/FEG	FE/MS/X/FEG	FE/MS/X/FEG	MS	FE/MS/FEG	FE/MS/X/FEG
Hmotnost 1000 ks (kg)	0,28	0,42	0,65	1,0	1,3	1,92	1,63

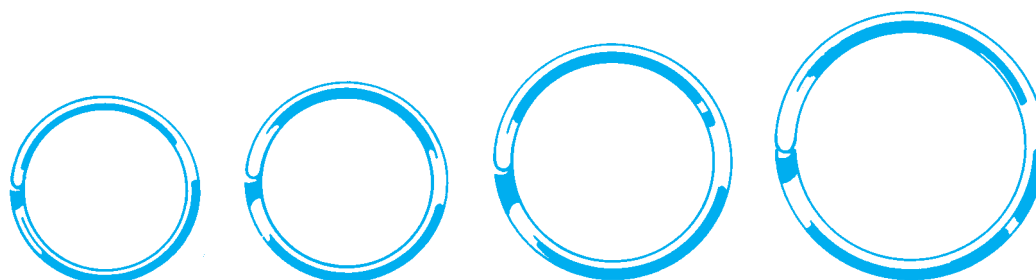
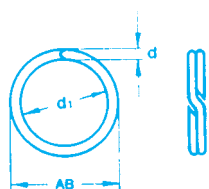

Druh č.	SP20	SP20ST	SP30	SP35
d (mm)	1,5	1,8	2,0	2,2
d1 x AB (mm)	20,7x24	22x26	26x30,5	30x35
Dodáváno v	FE/MS/X/FEG	FEG	FEG	FEG
Hmotnost 1000 ks (kg)	1,95	2,85	4,35	6,15

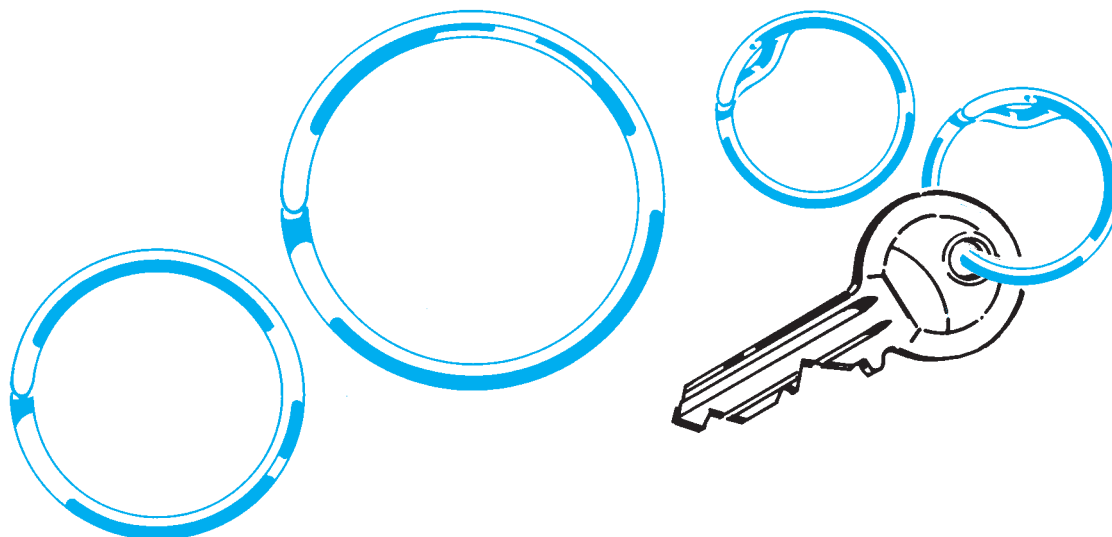

Druh č.	SP40	SP50	SP20ST/TR-PRO FEMAL
d (mm)	2,45	3,4	1,8
d1 x AB (mm)	32x38	43x50	21,5x25,5
Dodáváno v	FEG	FEG	FEG
Hmotnost 1000 ks (kg)	8,2	13,9	2,8

Materiál: FE = ocel, MS = mosaz, X = nerez, CU = měď, AL = hliník, P = plastická hmota, FEG = kalená ocel
 Uvedené zboží je bez atestu.

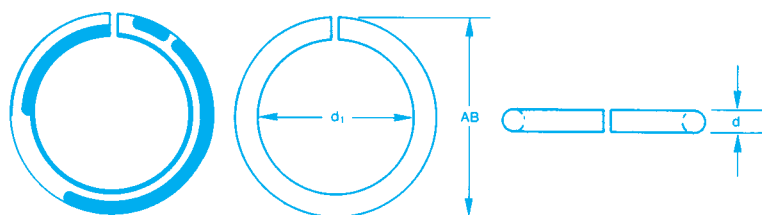

Otevřené kroužky



Druh č.	4x0,8	5x0,9	5x1,3	7x0,9	7x1,5	10x2	10x3	12x1,5	12x2,5	15x3	20x3
d (mm)	0,8	0,9	1,3	0,9	1,5	2,0	3,0	1,5	2,5	3,0	3,0
d1 x AB (mm)	4x5,6	5x6,8	5x7,6	7x8,8	7x10	10x14	10x16	12x15	12x17	15x21	20x26
Dodáváno v	FE/MS	FE/MS	FE/MS	FE	FE/MS	FE/MS/AL		FE	FE/MS	FE/MS	FE/MS
Hmotnost 1000 ks (kg)	0,06	0,09	0,21	0,11	0,37	0,96	2,25	0,6	1,73	3,13	4,09

Otevřené kroužky



Nesvařené kroužky

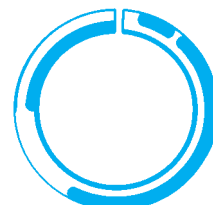

Druh č.	20x4	28x3,8	30x3	45x4,8	5x1,3	6x1,1	7x1,3	7x1,8	10x2	25x3,5	20x4
d (mm)	4,0	3,8	3,0	4,8	1,3	1,1	1,3	1,8	2,0	3,5	4,0
d1 x AB (mm)	20x28	28x35,6	30x36	45x54,6	5x7,6	6x8,2	7x9,6	7x10,6	10x14	25x32	20x28
Dodáváno v	FE	FE	FE	FE	FE	FE	FE	FE	FE	FE	FE
Hmotnost 1000 ks (kg)	8,14	9,0	5,84	22,52	0,2	0,18	0,29	0,56	0,92	6,2	7,39

Nesvařené kroužky

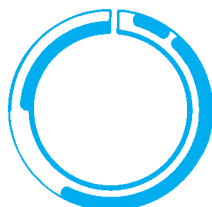

Svařené kroužky

Druh č.	20x5	25x5	21x8	34x4	34x5	35x4,6	35x4,8	40x8	47x3	60x8	10x2,1	20x2,0	20x3,0
d (mm)	5,0	5,0	8,0	4,0	5,0	4,6	4,8	8,0	3,0	8,0	2,1	2,0	3,0
d1 x AB (mm)	20x30	25x35	21x37	34x42	34x44	35x44,2	35x44,6	40x56	47x53	60x76	10x14,2	20x24	20x26
Dodáváno v	FE	FE	FE	FE	FE	FE	FE	FE	FE	FE	FE	FE	FE
Hmotnost 1000 ks (kg)	11,9	14,6	35,95	19,3	20,0	16,4	19,36	55,1	8,71	90,0	0,98	1,8	4,1

Svařené kroužky



Třmeny

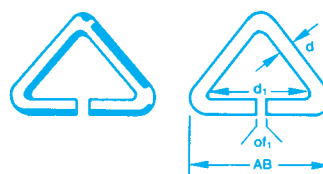

Druh č.	25x4	30x4	40x5	5413	5607	5003	5387	5420	5420	5378	5638	5340	5655	5519	B102
d (mm)	4,0	4,0	5,0	1,0	2,0	1,4	1,1	1,2	1,5	2,0	1,5	1,1	1,2	4,0	2,0
d1 x AB (mm)	25x33	30x38	40x50	6,6x8,6	10x14	14,3x17,1	8x10,2	8,8x11,2	8,6x11,6	15x19	9,6x12,6	6,1x8,3	11,2x13,6	25,7x33,4	13,8x17,8
of1				2,9	5,4	9,46	3,9	4,1	3,95	8,74	3,72	2,0	5,7	-	6,85
Dodáváno v	FE	FE	FE	FE	FE	FE	FE/MS	FE/MS	FE/MS	FE	FE	FE	FE	FE	FE
Hmotnost 1000 ks (kg)	10,5	10,2	21,2	0,12	0,76	0,33	0,16	0,24	0,37	0,9	0,36	0,13	0,24	7,63	0,96

Materiál: FE = ocel, MS = mosaz, X = nerez, CU = měď, AL = hliník, P = plastická hmota

Uvedené zboží je bez atestu.

PÖSAMO - Řetězárna, spol. s r. o., Zahradní 1094, 534 01 Holice, telefon: +420 466 681 228, fax: +420 466 681 229

<http://www.posamo.cz>, e-mail: posamo@holice.cz

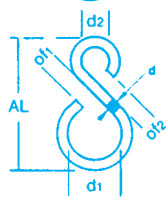

Druh č.	123	124	121	120	120ST	120/1,2	5380	116	115	114	115/7,5
d (mm)	0,8	1,0	1,5	1,0	1,3	1,2	1,4	1,6	1,8	2,0	1,7
d1 x AL (mm)	4x10	4x10	4x13	6x14	7x15	8x17	9x20	7x19	8x21	11x26	11x26
d2 (mm)	1,9	2,0	2,6	3,0	3,2	3,4	5,3	3,9	4,1	5,6	7,4
Dodáváno v	FE/MS	FE/MS/AL	FE/MS	FE/MS/X	FE/MS/X	FE/MS	FE/MS	FE/MS/X	FE/MS	FE/MS/X	FE/MS
Hmotnost 1000 ks (kg)	0,080	0,200	0,300	0,250	0,400	0,45	0,6	0,8	1,3	1,6	1,2

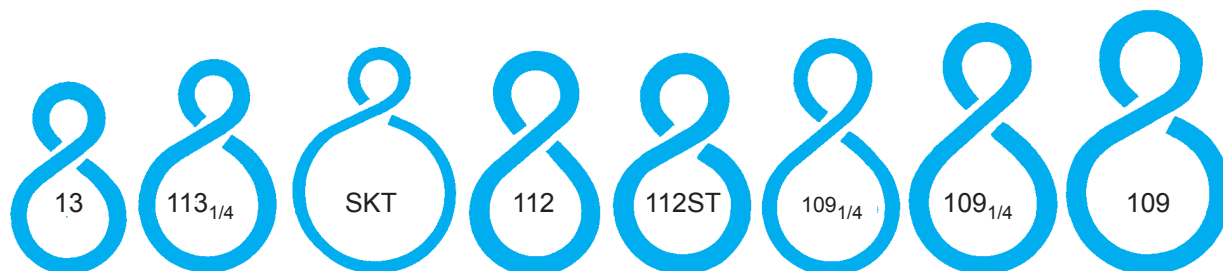

Druh č.	113	1131/4	SKT	112	112ST	109 ^(1/4)	109 ^{1/4}	109
d (mm)	2,3	2,3	1,8	2,7	3,0	2,0	2,7	3,0
d1 x AL (mm)	10x25	14x29	17x31	12x30	11x30	14x33	14x34	15x35
d2 (mm)	4,4	5,1	5,1	6,2	6,3	7,4	7,7	7,7
Dodáváno v	FE/MS/X	FE/MS	FE/MS/X	FE/MS/X	FE/MS	FE	FE/MS/X	FE/MS/X
Hmotnost 1000 ks (kg)	2,1	2,4	2,0	3,2	4,3	2,0	3,8	4,8

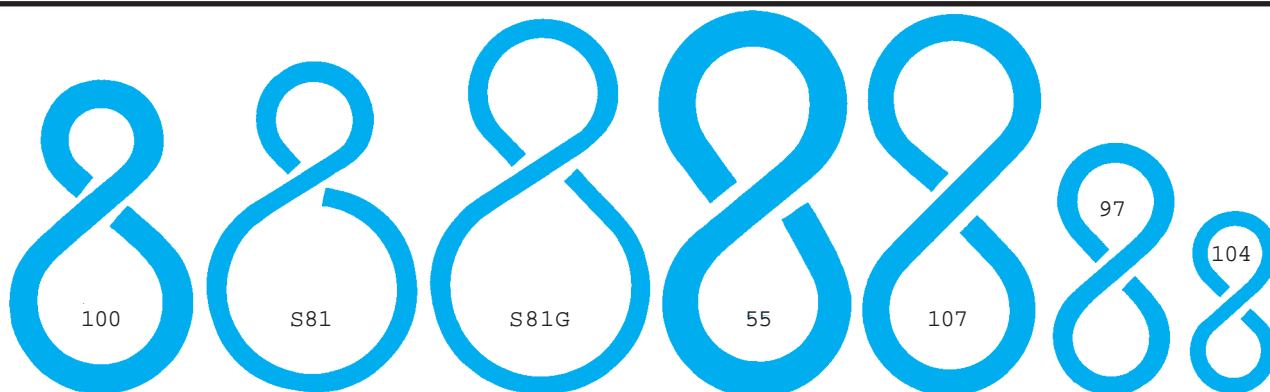

Druh č.	100	S81	S81G	55	107	97	104
d (mm)	3,8	2,8	2,8	4,8	3,8	2,4	2,3
d1 x AL (mm)	16x41	21x44	23x49	16x53	16x50	10x34	8x24
d2 (mm)	5,6	9,0	14,1	16,0	16,0	10,0	7,5
Dodáváno v	FE/MS/X	FE/MS/X	FE/MS	FE/MS	FE/MS	FE/MS	FE/MS/X
Hmotnost 1000 ks (kg)	10,3	5,5	6,5	16,0	11,0	4,5	2,3



Druh č.	105	93	116A	116P	1221/2	122	120ST-V	5432	5382	200
d (mm)	2,0	2,0	1,6	1,4	1,4	1,0	1,3	1,5	1,7	2,3
d1 x AL (mm)	8x24	6x19	6x19	5x16	4x14	3x11	5x14	5x15	8x22	11x29
d2 (mm)	7,5	6,0	6,0	5,0	6,5	3,0	3,7	3,7	5,6	7,5
Dodáváno v	FE/MS	FE/MS	FE/MS	FE/MS/X	FE/MS	FE/MS	FE/MS/X	FE/MS	FE/MS	FE
Hmotnost 1000 ks (kg)	1,7	1,05	0,67	0,6	0,4	0,18	0,40	0,5	0,95	2,4

Materiál: FE = ocel, MS = mosaz, X = nerez, CU = měď, AL = hliník, P = plastická hmota

Uvedené zboží je bez atestu.

PÖSAMO - Řetězárna, spol. s r. o., Zahradní 1094, 534 01 Holice, telefon: +420 466 681 228, fax: +420 466 681 229

<http://www.posamo.cz>, e-mail: posamo@holice.cz



Druh č.	5587	5545	5324	92	5379	113 ^{1/4} OF	5659	5652
d (mm)	1,5	2,0	1,7	3,0	2,3	2,3	3,0	2,5
d1 x AL (mm)	9x21	9x20	9x27	12x31	13x28	14x29	16x36	22x36
d2 (mm)	4,3	3,5	10,4	11,0	5,3	5,3	8,8	6,6
of1 (mm)	7,4	2,7	4,6	9,6	8,9	6,1	5,8	14,1
Dodáváno v	MS	MS	FE/MS	FE/MS	FE/MS	FE/MS	FE	X
Hmotnost 1000 ks (kg)	0,68	1,3	1,2	4,0	2,2	2,19	4,74	3,0



Druh č.	5493	5301	5367	5645	5527	5389	86	86	5641
d (mm)	1,5	2,0	2,0	2,0	2,0	2,2	2,2	2,8	3,8
d1 x AL (mm)	7x22	8x28	12x35	8x20	10x24	12x28	10x22	10x24	16x41
d2 (mm)	7,0	7,7	11,9	5,3	6,7	6,1	4,6	4,7	8,2
of1 (mm)	6,5	7,5	12,2	4,1	3,9	4,4	7,1	6,8	10,9
of2 (mm)	6,5	7,7	11,9	2,7	2,5	3,5	2,4	2,2	4,3
Dodáváno v	FE	FE	FE/MS	FE	FE	FE	FE	FE	X
Hmotnost 1000 ks (kg)	0,6	1,5	1,9	1,13	1,4	1,9	1,7	2,9	9,16

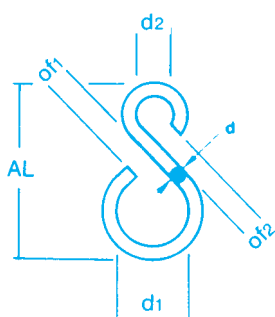

Druh č.	5334	77	77	78
d (mm)	3,0	3,2	3,6	4,5
d1 x AL (mm)	23x42	28x53	28x53	31x61
d2 (mm)	9,5	7,8	8,1	10,1
of1 (mm)	11,7	16,7	14,7	20,5
of2 (mm)	4,1	4,3	4,6	4,6
Dodáváno v	FE	FE	FE	FE
Hmotnost 1000 ks (kg)	5,5	6,8	9,2	16,5

Materiál: FE = ocel, MS = mosaz, X = nerez, CU = měď, AL = hliník, P = plastická hmota

Uvedené zboží je bez atestu.

PÖSAMO - Řetězárna, spol. s r. o., Zahradní 1094, 534 01 Holice, telefon: +420 466 681 228, fax: +420 466 681 229

<http://www.posamo.cz>, e-mail: posamo@holice.cz

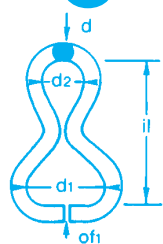

Svorníky

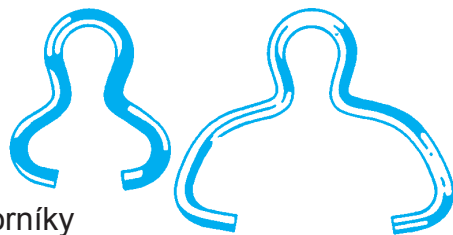

Pojistné S-háky

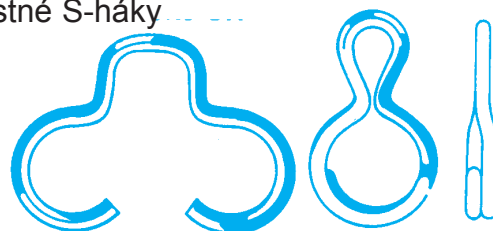

Druh č.	5635	5634	5633
d (mm)	3,0	3,0	3,0
d1 x il (mm)	11x22	26x31	14x28
d2 x of1 (mm)	6x9	6x23	6x11
Dodáváno v	FE	FE	FE
Hmotnost 1000 ks (kg)	3,8	5,4	5,9

Nouzové S-háky

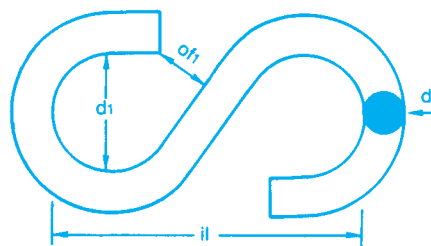

Druh č.	30	40	50	60	70
d (mm)	3,0	4,0	5,0	6,0	7,0
d1 x il (mm)	7x20	9x28	12x34	13x42	17x52
of1 (mm)	3	4	5	6	7
Zatížení - ocel (N)	100	250	400	500	600
Dodáváno v	FE/X	FE/X	FE/X	FE	FE
Hmotnost 1000 ks (kg)	3,1	7,0	13,0	22,4	37,7

Nouzové články

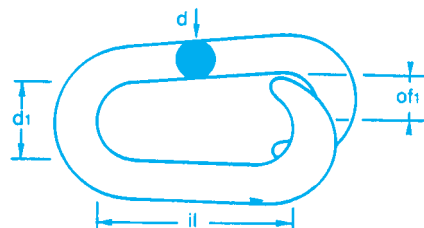

Druh č.	30	40	50	60	80
d (mm)	3,0	4,0	5,0	6,0	8,0
d1 x il (mm)	7x16	9x19	9x23	11x28	16x37
of1 (mm)	9	12	7	11	13
Zatížení - ocel (N)	150	350	580	700	1000
Dodáváno v	FE	FE	FE	FE	FE
Hmotnost 1000 ks (kg)	3,4	7,4	14,1	24,6	59,4

Rapid články

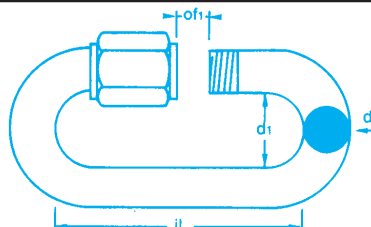
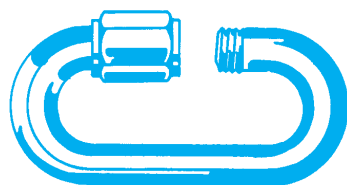

Druh č.	RA40	RA50	RA60	RA80
d (mm)	4,0	5,0	6,0	8,0
d1 x il (mm)	11x31	13x39	14x45	17x58
of1 (mm)	5,5	6,5	7,5	10
Zatížení - ocel (N)	400	1000	1500	2700
Dodáváno v	FE/X	FE/X	FE/X	FE/X
Hmotnost 1000 ks (kg)	13,5	23,0	39,0	78

Materiál: FE = ocel, MS = mosaz, X = nerez, CU = měď, AL = hliník, P = plastická hmota

Uvedené zboží je bez atestu.

Třmeny

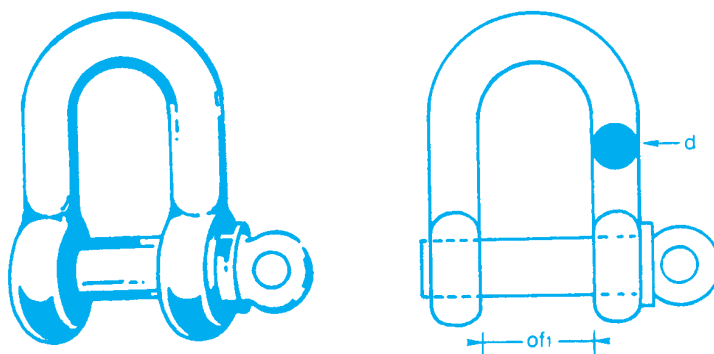

Druh č.	3/16" (ø 5)	1/4" (ø 6)	5/16" (ø 8)	3/8" (ø 10)	1/2" (ø 12)	5/8" (ø 16)
of1 x il (mm)	10x19	13x25	16x32	19x38	25x51	32x64
Zatížení - ocel (N)	800	1000	2000	3000	5000	8000
Dodáváno v	FE/X	FE/X	FE/X	FE/X	FE	FE
Hmotnost 1000 ks (kg)	16,0	32,0	70,0	134,0	250	530,0

Karabiny

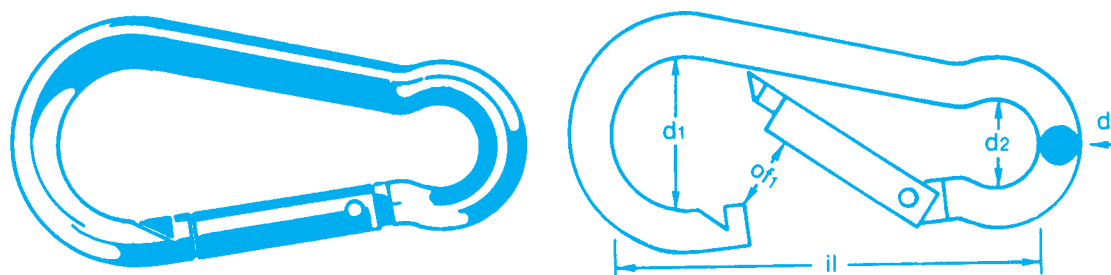

Druh č.	40x4	50x5	60x6	70x7	80x8	100x10	120x11
d (mm)	4,0	5,0	6,0	7,0	8,0	10,0	11,0
d1 x il (mm)	12x30	12x40	15x48	21x56	24x64	30x80	37x98
d2 x of1 (mm)	7x7	8x7	9x9	10x10	12x9	15x12	17x15
Zatížení - ocel (N)	600	1000	1200	1500	2300	3500	4000
Dodáváno v	FE	FE/X	FE/X	FE/X	FE/X	FE/X	FE
Hmotnost 1000 ks (kg)	11,0	13,0	27,0	44,0	65,0	127,0	184,0

Kladky

jednoduché

dvojitě

ORIENTAČNÍ NOSNOST:
do 15 kg

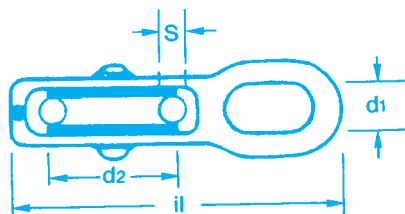

Druh č.	1/2"	1"	1 1/2"	2"	1/2"	3/4"	1"	1 1/4"	2"
d1 x il (mm)	4,76x40	6,35x55	9,54x75	12,7x100	4,76x40	4,76x45	6,35x55	9,54x65	2,7x100
d2 (mm)	12,7	25,4	38,10	50,8	12,7	19,05	25,4	31,75	50,8
Průměr lana S (mm)	4,0	4,8	6,35	9,54	4,0	4,0	4,8	6,35	9,54
Dodáváno v	FE	FE	FE	FE	FE	FE	FE	FE	FE
Hmotnost 1000 ks (kg)	31,3	58,0	140,0	280	46,7	70,0	93,3	166,7	416,7

Materiál: FE = ocel, MS = mosaz, X = nerez, CU = měď, AL = hliník, P = plastická hmota

Uvedené zboží je bez atestu.

Karabiny

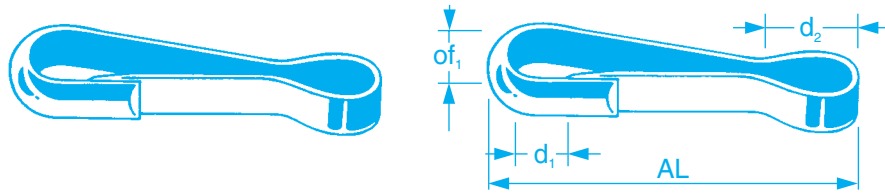

Druh č.	12/25	12x30	12x35	12/40	12/50	12/60	12/70	12/80	12/100	12/120
d1 x il (mm)	5x25	6x30	7x35	8x40	10x50	11x60	14x70	15x80	17x100	22x120
d2 x of1(mm)	5x3	5x4	7x5	8x5	9x6	10x7	11x10	12x11	15x13	17x15
Dodáváno v	FE	FE	FE	FE/X	FE/X	FE/X	FE	FE	FE	FE
Hmotnost 1000 ks (kg)	1,50	1,80	2,70	3,80	7,50	12,0	19,0	28,0	52,0	91,0

Karabiny

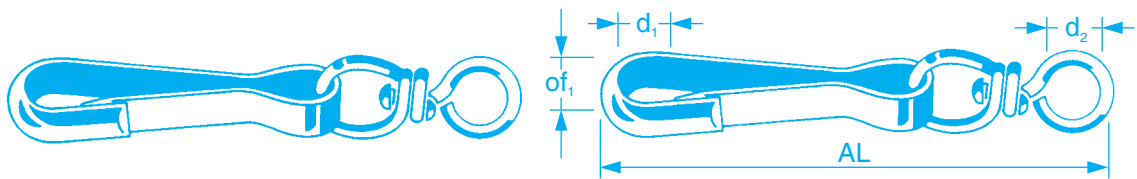

Druh č.	12W/25	12W/30	12W/35	12W/40	12W/50	12W/60	12W/70	12W/80	12W/100	12W/120
d1 x il (mm)	6x45	6x50	7x60	8x65	10x80	11x100	14x115	15x125	17x145	22x165
d2 x of1(mm)	7x3	6x4	8x5	10x5	9x6	11x7	12x10	12x11	19x13	17x15
Dodáváno v	FE	FE	FE	FE	FE	FE	FE	FE	FE	FE
Hmotnost 1000 ks (kg)	3,7	4,2	5,1	7,7	13,6	21,0	33,0	40,0	75,0	138,0

Karabiny

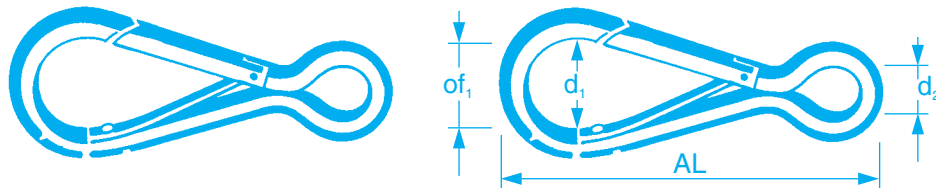

Druh č.	4/35	4/40	4/50	4/60	4/70	4/80
d1 x il (mm)	8x35	10x40	14x50	15x60	18x70	20x80
d2 x of1(mm)	5x4	6x5	7x6	8x7	9x10	10x11
Dodáváno v	FE	FE	FE	FE/X	FE	FE
Hmotnost 1000 ks (kg)	6,0	7,0	12,5	22,0	25,0	39,5

Karabiny

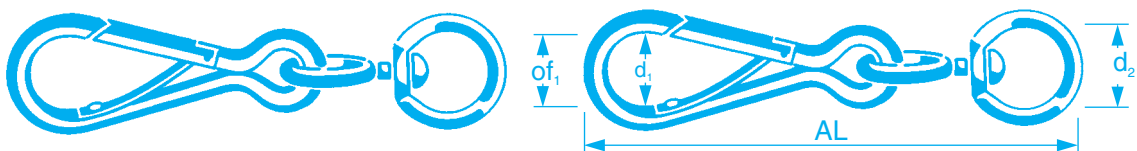

Druh č.	5/40	5/50	5/60	5/70
d1 x il (mm)	10x85	14x95	15x105	18x115
d2 x of1(mm)	10x5	12x6	15x7	16x10
Dodáváno v	FE	FE	FE	FE
Hmotnost 1000 ks (kg)	10,0	15,0	29,0	36,0

Otočné karabiny

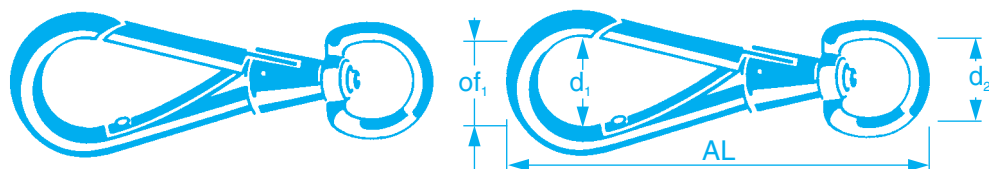

Druh č.	10/40	10/50	10/60	10/70
d1 x AL (mm)	9x40	11x50	12x60	14x70
d2 x of1(mm)	10x4	11x6	15x6	16x9
Dodáváno v	FE	FE	FE	FE
Hmotnost 1000 ks (kg)	6,0	12,0	15,0	24,0

Druh č.	8/50	8/60	8/70	8/80
d1 x AL (mm)	7x50	7x60	8x70	10x80
d2 x of1(mm)	11x5	14x6	15x6	19x6
Dodáváno v	FE	FE	FE	FE
Hmotnost 1000 ks (kg)	15,0	20,0	29,0	58,0

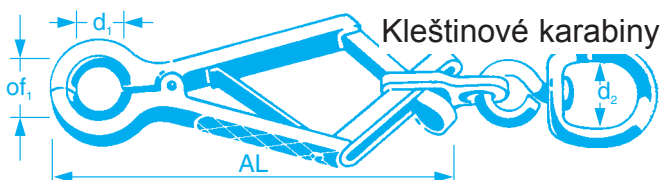

Kleštinové karabiny

Materiál: FE = ocel, MS = mosaz, X = nerez, CU = měď, AL = hliník, P = plastická hmota
Uvedené zboží je bez atestu.

Karabiny

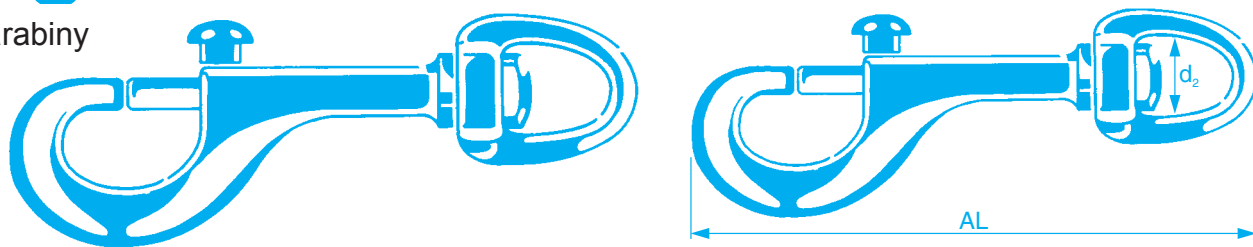

Druh č.	K52	K78
d2 x AL (mm)	6x52	16x78
Dodáváno v	Z	Z
Hmotnost 1000 ks (kg)	11,0	30

Plechové karabiny

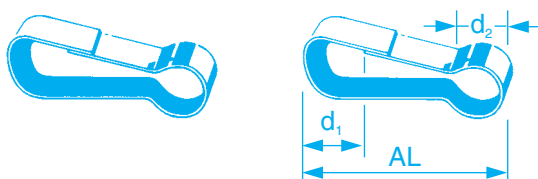

Druh č.	5538	5605	5623	5555	5572
AL (mm)	24	29	31	31	31
d1 x d2 (mm)	5x4	5x5	6x7	8x8	8x8
Dodáváno v	FE	FE	FE	FE	FE
Hmotnost 1000 ks (kg)	0,2	0,9	0,9	1,4	1,8

Plechové karabiny

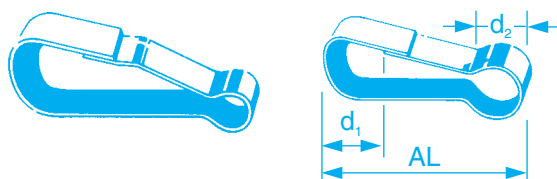

Druh č.	1/15	1/20	1/27S	1/27B	13/30
AL (mm)	15	20	27	27	30
d1 x d2 (mm)	3x2	5x3	8x4	8x4	8x6
Dodáváno v	MS	FE/MS	FE/MS	FE/MS	FE/MS
Hmotnost 1000 ks (kg)	0,24	0,5	0,75	0,95	1,85

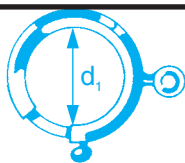

Mosazné otočné karabiny

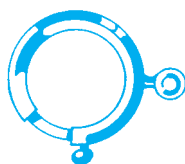

Pružné kroužky

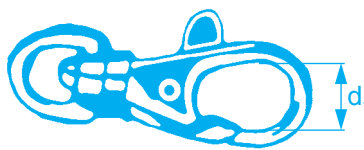

Karabiny S1



Druh č.	2184	6,0	9,2	18	S1	2285	2286
d1 (mm)	4,7	3,5	5,3	12,9	8,5	14	19,5
Dodáváno v	MS	MS	MS	MS	Z	FE	FE
Hmotnost 1000 ks (kg)	1,61	0,17	0,39	1,50	6,9	2,80	5,68

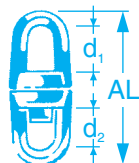

Otočné klouby

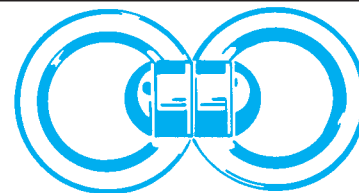

Druh č.	DW16	DW20	WB20(30)	WB40	WB60	LW50	LW60	LW70
d1 x AL (mm)	2,9x16	4,5x20	7x30	7x31	9x38	19x50	20x60	24x70
d2 x AL (mm)	2,4	3,5	9	10	11	19	20	24
Dodáváno v	Z	Z	FE	FE	FE	FE	FE	FE
Hmotnost 1000 ks (kg)	1,23	2,03	2,56	3,20	8,34	30	35	65

Materiál: FE = ocel, MS = mosaz, X = nerez, CU = měď, AL = hliník, P = plastická hmota, Z = zinek

Uvedené zboží je bez atestu.

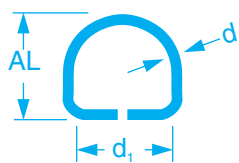

Druh č.	0461/12	2308	1640	5272	1640
d (mm)	1,2	2,0	2,4	2,8	2,8
d1 x AL (mm)	12x14	15x16	15x16	15x16	18x19
Svařené/otevřené	svařené	otevřené	otevřené	otevřené	otevřené
Dodáváno v	FE	FE	FE	FE	FE
Hmotnost 1000 ks (kg)	1,3	1,3	1,8	2,5	3,0



Druh č.	5325	5547	5423	5588
d (mm)	2,5	4,0	3,0	3,0
d1 x AL (mm)	18x20	18x20	21x20	27x23
Svařené/otevřené	otevřené	otevřené	otevřené	otevřené
Dodáváno v	FE	FE	FE	FE
Hmotnost 1000 ks (kg)	2,5	6,2	3,9	4,7



Druh č.	2301	2301	2301	5651	1640/36
d (mm)	2,3	2,8	3,4	2,8	4,4
d1 x AL (mm)	23x26	23x27	20x28	32x27	36x33
Svařené/otevřené	otevřené	otevřené	otevřené	otevřené	svařené
Dodáváno v	FE	FE	FE	FE	FE
Hmotnost 1000 ks (kg)	2,9	4,0	6,1	5,2	14,0

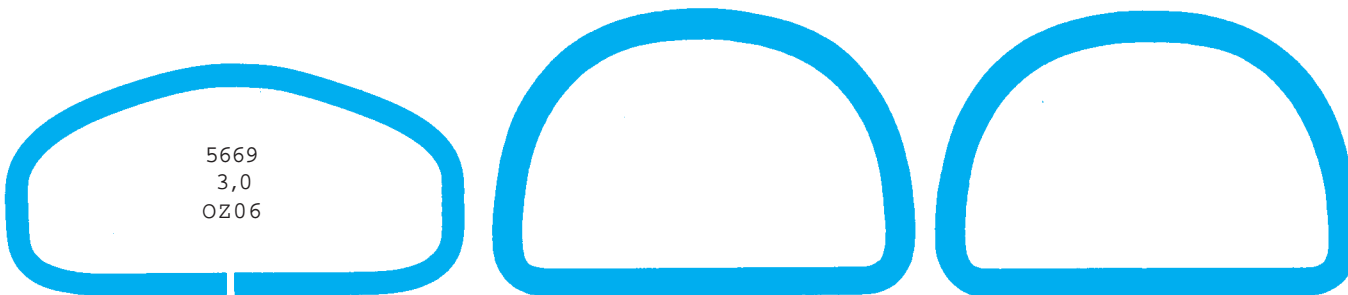

Druh č.	5669	1640/45	1640/48
d (mm)	3,0	4,5	4,8
d1 x AL (mm)	52x25	45x36	48x36
Svařené/otevřené	otevřené	svařené	svařené
Dodáváno v	FE	FE	FE
Hmotnost 1000 ks (kg)	8,4	19,9	20,0

Materiál: FE = ocel, MS = mosaz, X = nerez, CU = měď, AL = hliník, P = plastická hmota

Uvedené zboží je bez atestu.

Očka se závitem

dodávána otevřená
nebo zavřená

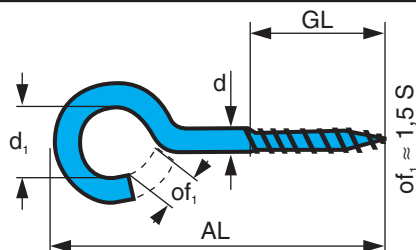

Druh č.	12x1,20	15x1,40	18x1,50	20x1,80	23x2	25x2,20	30x2,50
d (mm)	1,2	1,4	1,5	1,8	2,0	2,2	2,5
d1 x AL (mm)	3x12	3x15	3x18	3x20	3x23	4x25	4x30
of1 x AL (mm)	1,8	2,1	2,2	2,7	3	3,3	3,7
GL (mm)	6	6	6	6	6	10	12
Dodáváno v	FE/MS	FE/MS	FE/MS	FE/MS	FE/MS	FE/MS	FE/MS
Hmotnost 1000 ks (kg)	0,165	0,256	0,320	0,515	0,775	1,020	1,450

Pružné zástrčky

dvojité

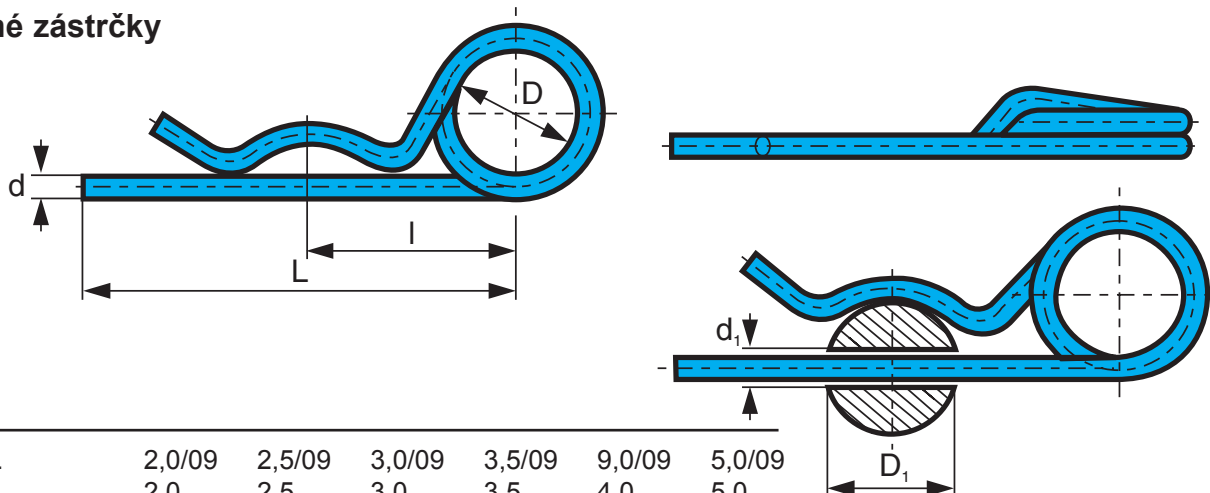

Druh č.	2,0/09	2,5/09	3,0/09	3,5/09	9,0/09	5,0/09
d	2,0	2,5	3,0	3,5	4,0	5,0
Dodáváno v	FE	FE	FE	FE	FE	FE

Pružné zástrčky

jednoduché

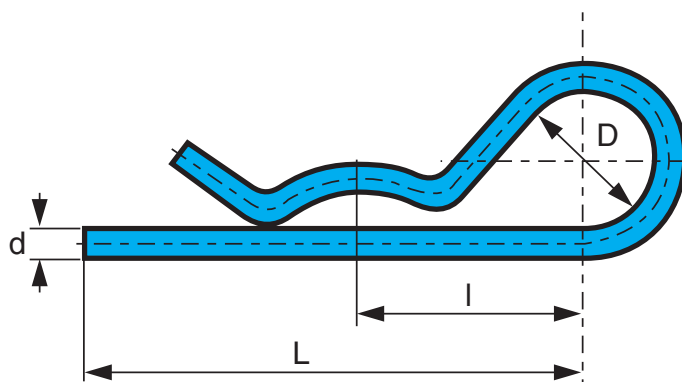

Druh č.	1,4/09	2,0/09	3,0/09	4,0/09	5,0/09	6,3/09
d	1,4	2,0	3,0	4,0	5,0	6,3
Dodáváno v	FE	FE	FE	FE	FE	FE

Materiál: FE = ocel, MS = mosaz, X = nerez, CU = měď, AL = hliník, P = plastická hmota

Uvedené zboží je bez atestu.

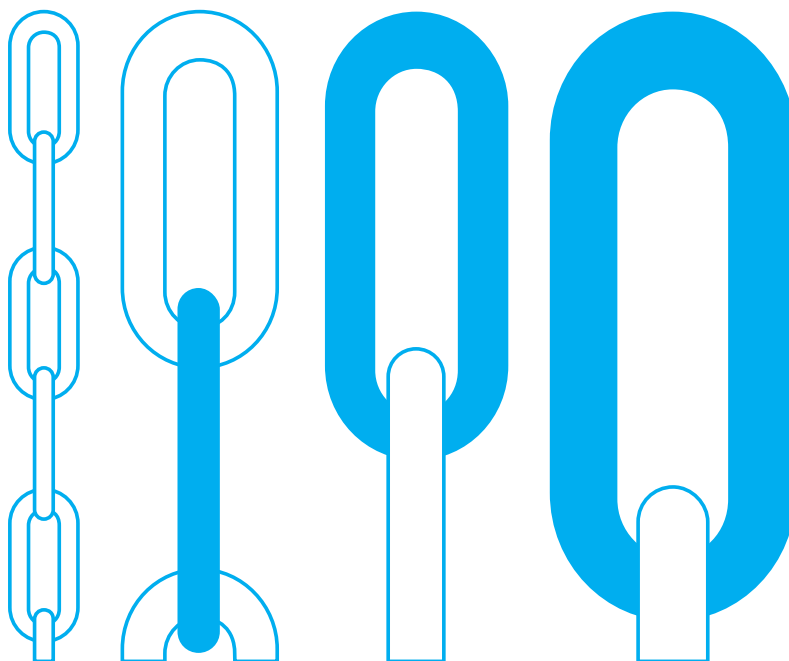
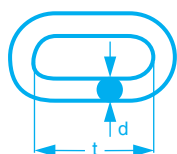

Druh č.	Plast 2,0	Plast 6,0	Plast 8,0	Plast 10,0
d (mm)	2,0	6,0	8,0	10,0
t (mm)	10	40,5	49	69
Vnější šířka (mm)	8	22,5	26,5	35
Hmotnost 100 m (kg)	1,0	8,0	12,8	22,5

Řetězy z plastické hmoty

Výběr barev:
dodává se = x

	<u>červeno-bílá</u>	<u>černo-žlutá</u>	<u>červena</u>	<u>měděná</u>	<u>bílá</u>	<u>černá</u>
2,0					x	x
6,0	x	x	x		x	x
8,0	x	x	x		x	x
10,0				x		x

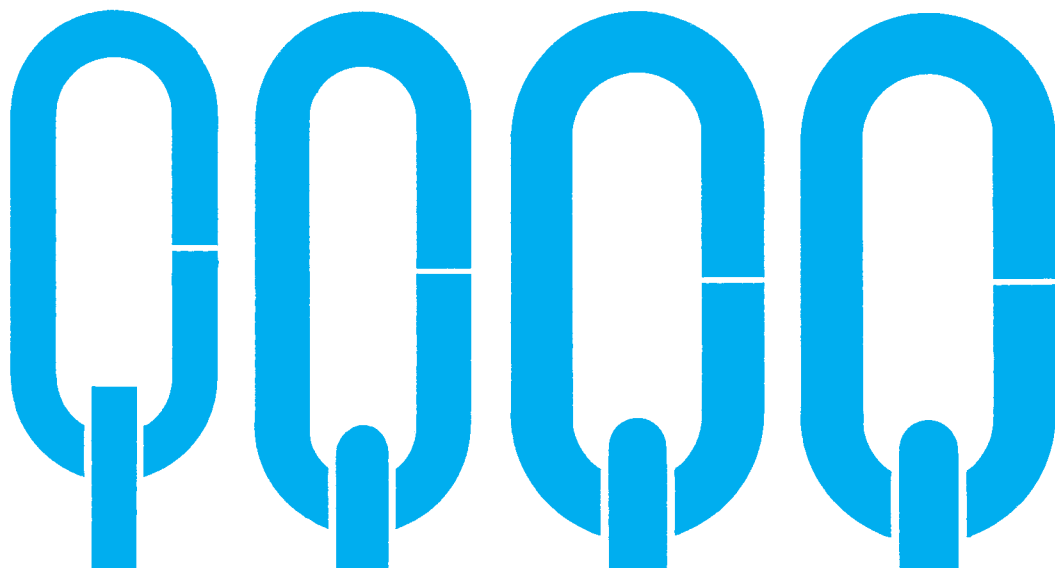
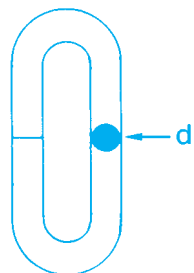

Druh a d (mm)	1638 n 6,0	1824 I 7,0	1858 I 8,0	1858 I 8,0
t (mm)	50	55	53,5	53,5
Vnější šířka (mm)	27	28	32,5	32,5
Zatížení – ocel (N)	1450	1550	–	–
Zatížení – mosaz (N)	950	990	–	–
Materiál a povrchová úprava	mosaz - brunýr.	měď leštěná	hliník černý	hliník surový

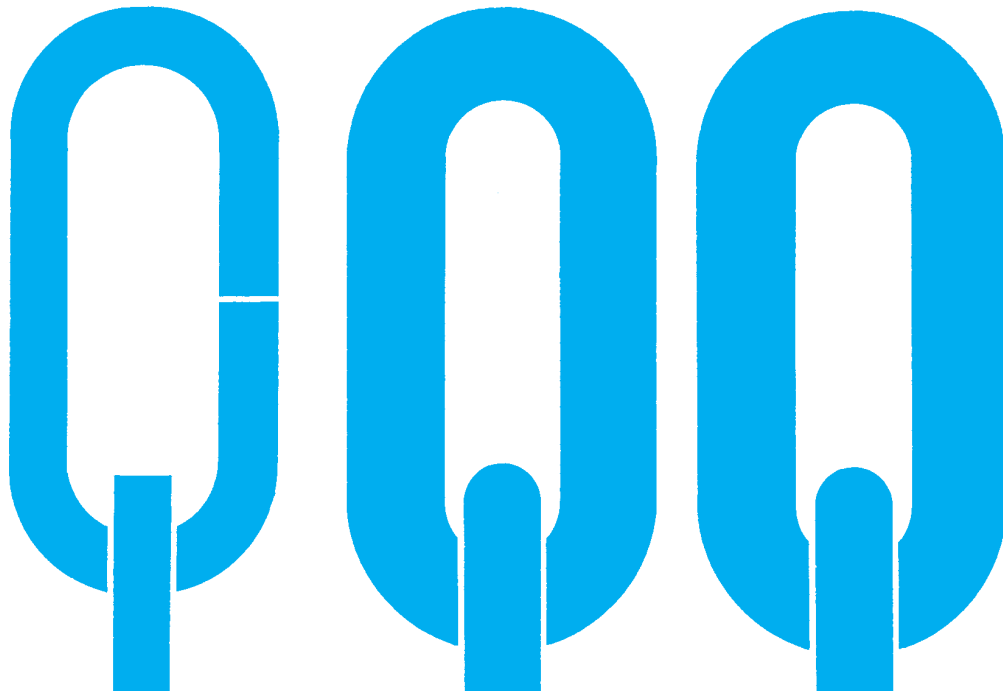

Druh a d (mm)	1852 n 8,0	40x90 I 10,0	40x90 I 10,0
t (mm)	66	64	64
Vnější šířka (mm)	37	41,5	41,5
Zatížení – ocel (N)	1850	–	–
Zatížení – mosaz (N)	1200	990	–
Materiál a povrchová úprava	ocel pozink. černá	polyetylén, barva mědi	polyetylén, černý (odolnost teplotě až -30 °C)

Uvedené zboží je bez atestu.

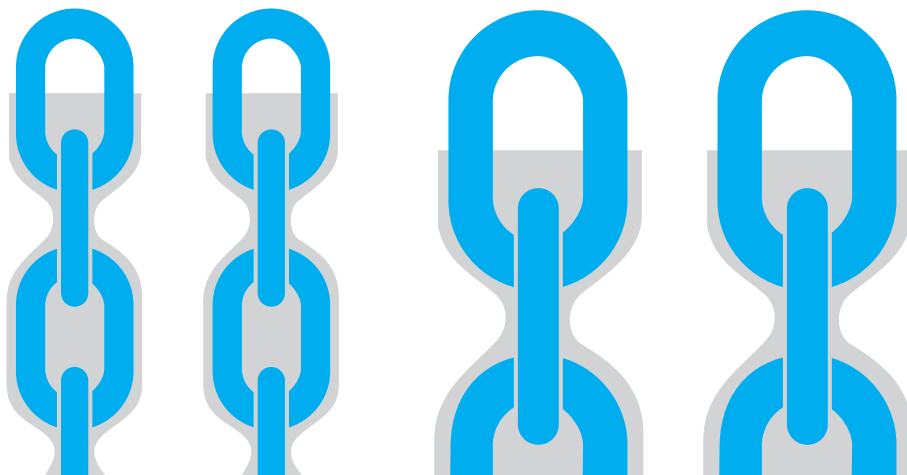

Rozměr Pro třmen zámku až (mm)	4 x 700 mm 6	4 x 1000 mm 6	6 x 900 mm 11	6 x 1200 mm 11
-----------------------------------	-----------------	------------------	------------------	-------------------

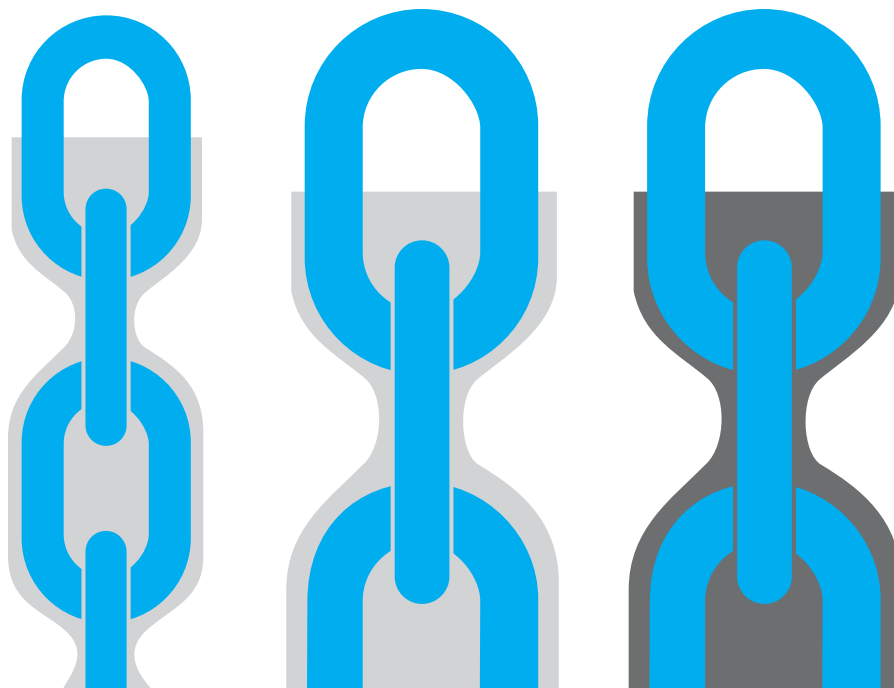

Rozměr Pro třmen zámku až (mm)	6 x 2400 mm 11	8 x 1000 mm 14	8 x 1000 mm 14,5
-----------------------------------	-------------------	-------------------	---------------------

Uvedené zboží je bez atestu.

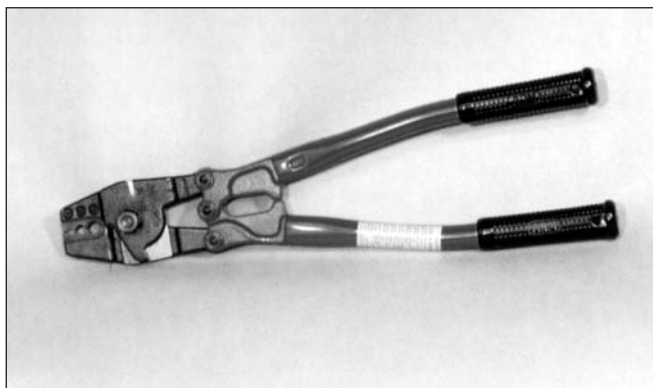

Univerzální kleště HSC 350 pro svorky od OS-1A do OS-3B

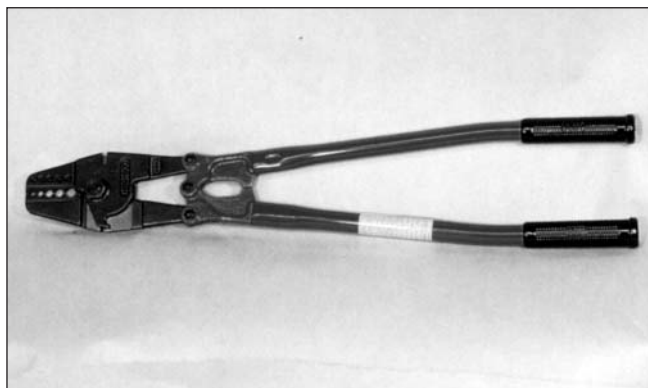

Univerzální kleště HSC 600 pro svorky od OS-1A do OS-5A

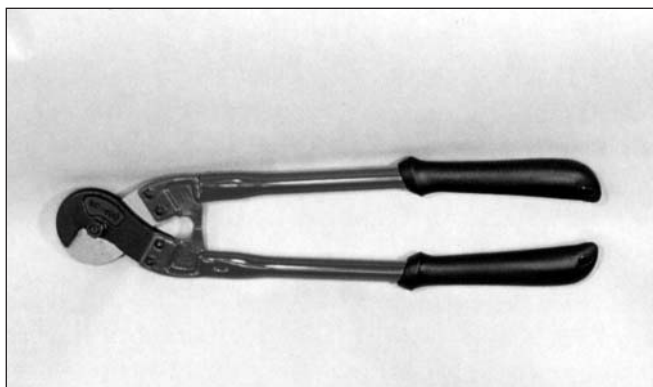

Štípací kleště RC 450 pro lana až 12 mm

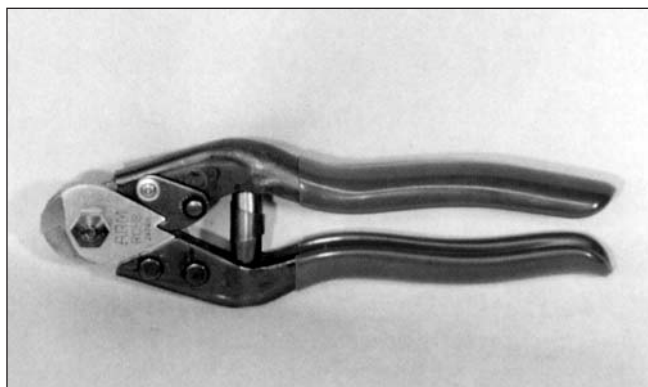

Štípací kleště RC 8 pro lana až 5 mm

Použití:

1. Přeštípnete lano v požadované délce.
2. Provléknete lano svorkou a utvoříte smyčku.

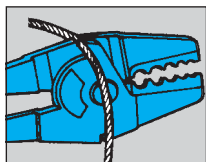

Vyčnívající konec lana musí být 1,5 krát delší než je rozměr průměru lana.

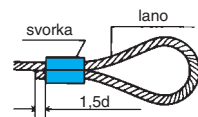

3. Např. OS 3A je svorka určená pro otvor č. 3 univerzálních kleští.

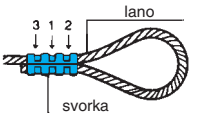

Svorka se nejprve stiskne uprostřed.

4. Druhé stisknutí ke straně smyčky. Třetí stisknutí na konci lana.

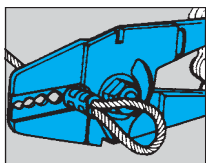

POZOR!!!

Lisování provést jedním zmáčknutím, ne vícekrát.

Počet prolisování závisí na velikosti svorek.

Např.
OS-1A 1B ... 2x
OS-1A 5A ... 3x

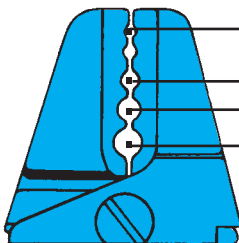

Příslušné svorky lisujte pouze odpovídajícím typem kleští firmy PÖSAMO.

Otvor č.	Model	Lisovací svorky	Průměr lan	
			mm	inch
①	OS-1A		1,5	1/16
	OS-1B		2	5/64
②	OS-3A		3	1/8
③	OS-4A		4	5/32
④	OS-5A		5	3/16

Test v solné mlze trvající 72 hodin prokázal, že hliníkové svorky mohou být použity s nerezovými lany.

Uvedené zboží je bez atestu.

Lana dodáváme od průměru 1 mm do průměru 8 mm v těchto provedeních:

- ocelová pozinkovaná
- ocelová pozinkovaná, opláštěvaná PVC
- mosazná
- nerezová

Všechny typy lan jsou umrtvené.

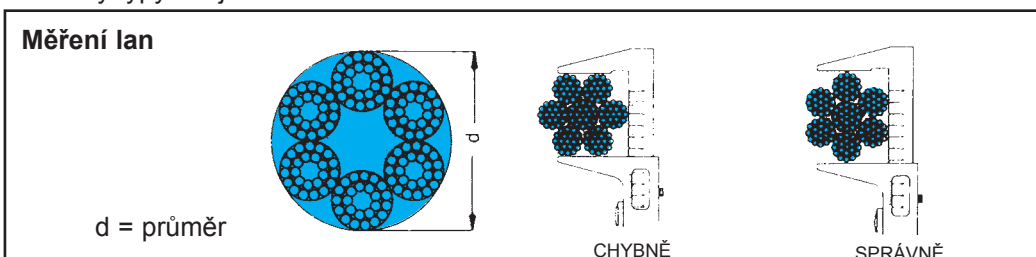
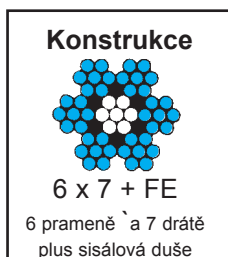

Ocelová lana pozinkovaná				
Lano Ø (mm)	Plášť Ø (mm)	Konstrukce	Dovolené zatížení (kN)	Cívka (m)
1,0		4X3 + 1FE	0,53	200
1,5		6X3 + 1FE	1,24	300
2,0		5X7 + 1FE	2,43	300
3,0		6X7 + 1FE	5,07	300
4,0		6X7 + 1FE	9,40	200
5,0		6X7 + 1FE	14,10	100
6,0		6X7 + 1FE	18,70	130
8,0		6X12 + 7FE	21,60	70
Ocelová lana pozinkovaná, opláštěvaná v PVC				
1,5	3,0	6X3 + 1FE	1,24	300
3,0	5,0	6X7 + 1FE	5,07	100
4,0	6,0	6X7 + 1FE	9,40	130
6,0	8,0	6X7 + 1FE	18,70	70
Mosazná lana				
1,5		6X3 + 1FE	0,30	200
1,8		6X7 + 1FE	0,46	150
Nerezová lana				
1,0				
1,5				
2,0				200
3,0				200
4,0				100
5,0				100
6,0				85

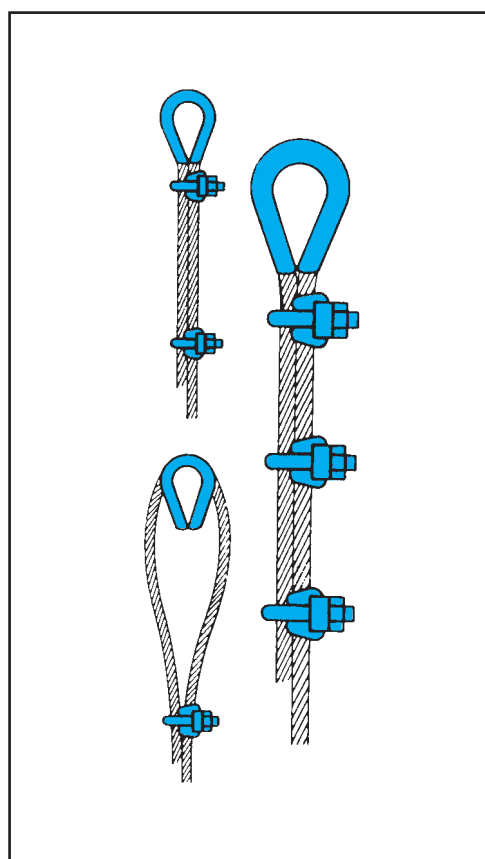

Svěrky

pro lana Ø (mm)	
3 mm	matice M4
5 mm	matice M5
6,5 mm	matice M5
8 mm	matice M6
10 mm	matice M8
13 mm	matice M10
16 mm	matice M12

Očnice

pro lana Ø (mm)	
3 mm	
4 mm	
5 mm	
6 mm	
8 mm	

Napínací šrouby

napínací délka	
M5 x 50 mm	M5 x 70
M6 x 60 mm	M6 x 110
M8 x 110 mm	
M10 x 150 mm	

Uvedené zboží je bez atestu.

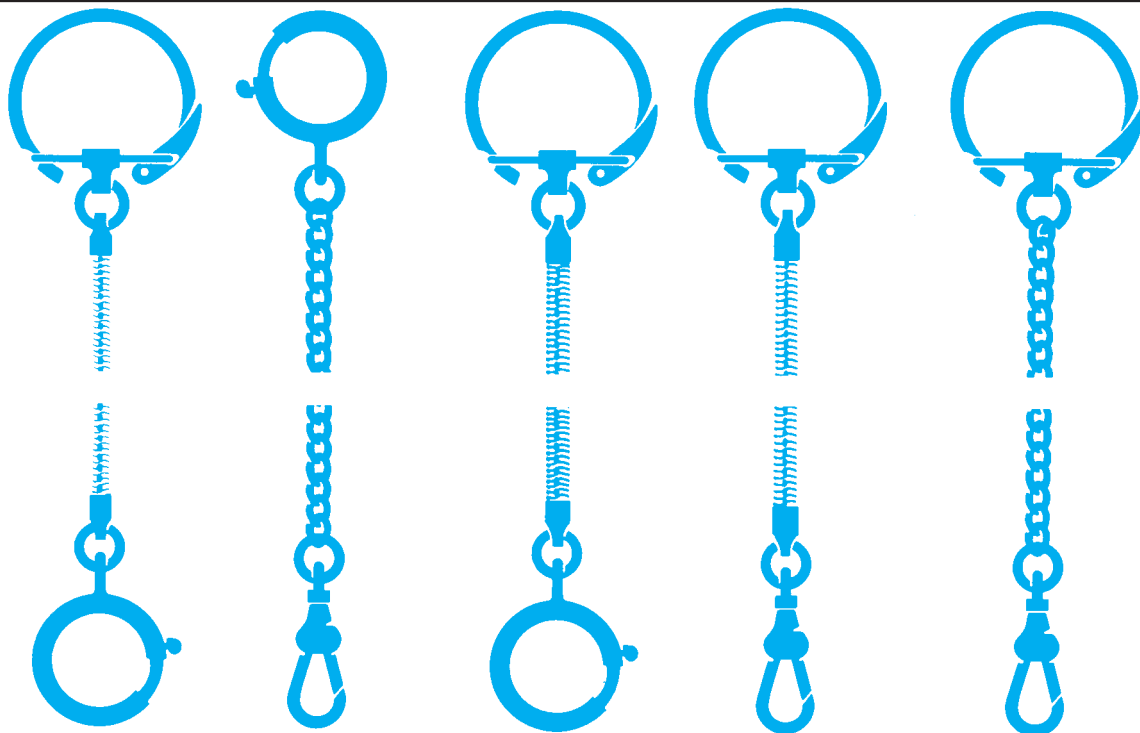

Druh	E301	E303	E309	E311	E312
Průměr řetízku (mm)	2,4	1,0	3,2	3,2	1,0
Celková délka (cm)	42	45	42	42	46
Materiál - povrch. úprava	mosaz pochrom.	mosaz pochrom.	mosaz pochrom.	mosaz pochrom.	ocel pochrom.

Druh	E318	E319
Průměr řetízku (mm)	2,0	2,0
Celková délka (cm)	48	46
Materiál - povrch. úprava	ocel – poníkl.	ocel – poníkl.

Druh	E331	E332	E333
Průměr řetízku (mm)	2,0	2,0	2,0
Celková délka (cm)	45	44	44
Materiál - povrch. úprava	ocel – poníkl.	ocel mosaz.	

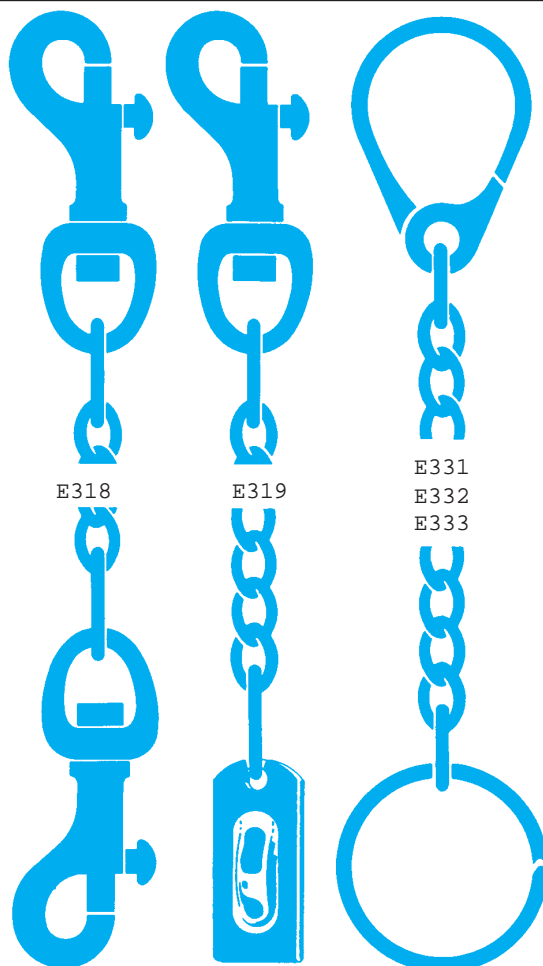

Uvedené zboží je bez atestu.

Řetízky k umyvadlům

Pochromovaná mosaz

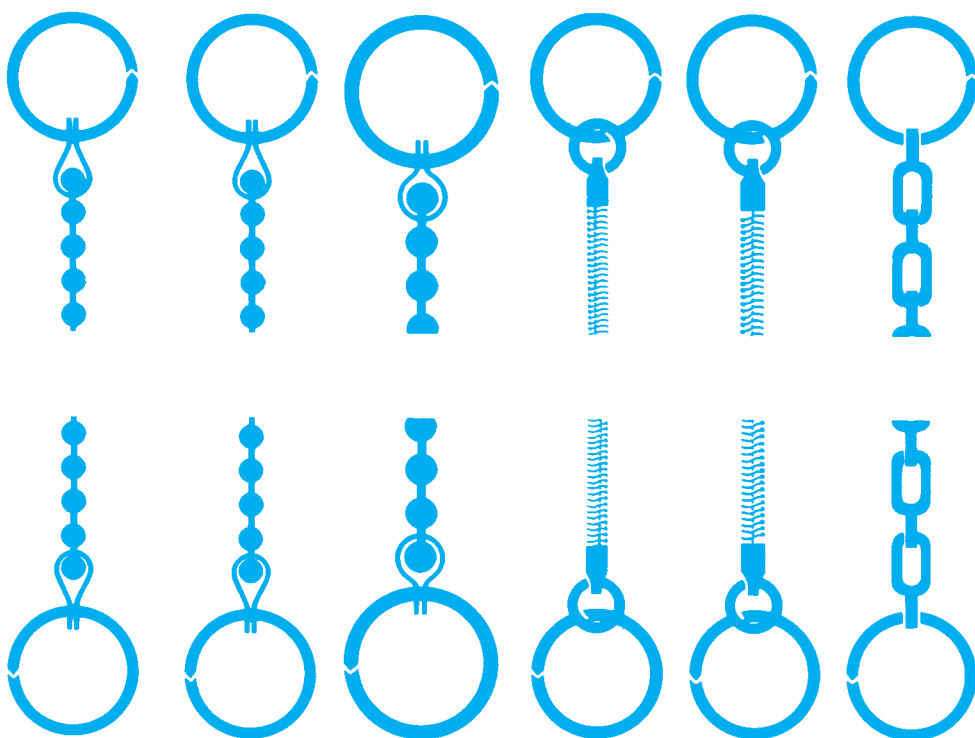
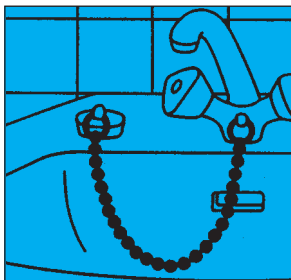

Druh č.	V25	V30	L30	E300	E304	L81/2D
Průměr řetízku (mm)	3,6	3,6	4,5	2,4	3,2	0,4
Celková délka (cm)	25	30	30	34	34	30

Řetízky k vanám

Pochromovaná mosaz

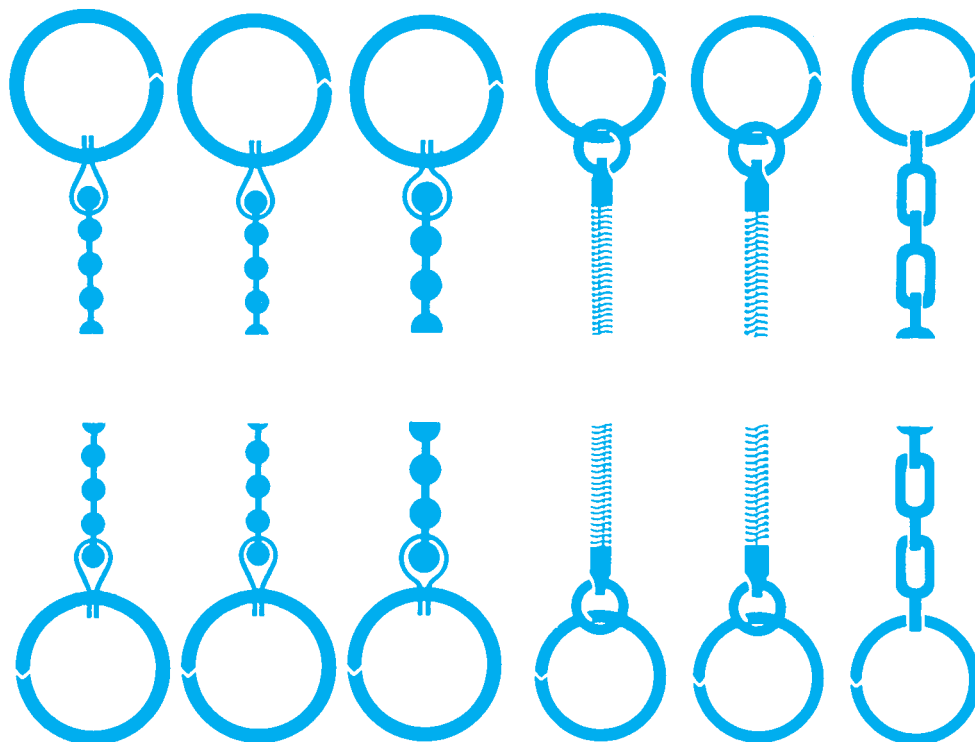

Druh č.	V40	V50	L50	E302	E305	L81/2D
Průměr řetízku (mm)	3,6	3,6	4,5	2,4	3,2	0,4
Celková délka (cm)	40	50	50	55	55	50

Uvedené zboží je bez atestu.

KROUŽKY DU

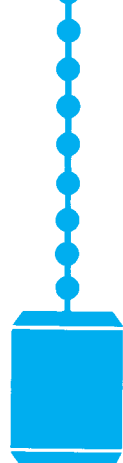
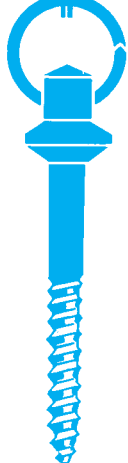
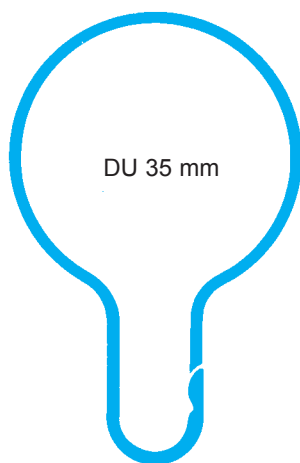
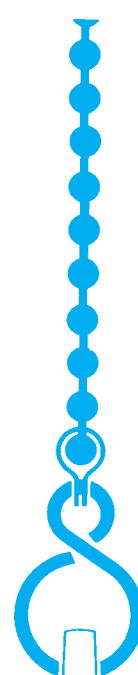
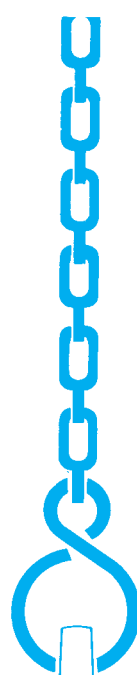
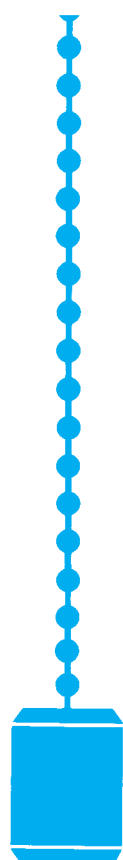
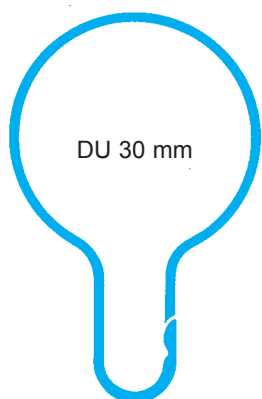
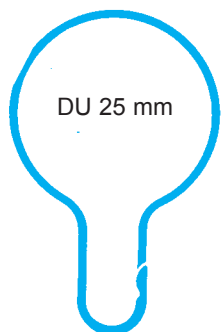

Druh č.	K7/3,6 – 2970	K7/3,6 – 2980	K7/3,6 – 20GR
Průměr řetízku (mm)	3,6	3,6	3,6
Celková délka (cm)	35	33,5	38

4080 – 81/2D
0,4
102

4080 – K10/4,5
4,5
102

Uvedené zboží je bez atestu.

Závěsné řetízky pro zavěšování květin

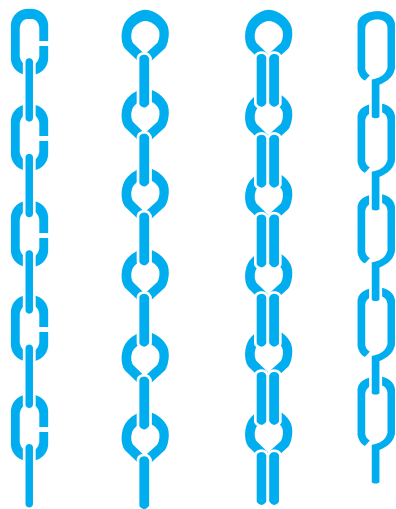
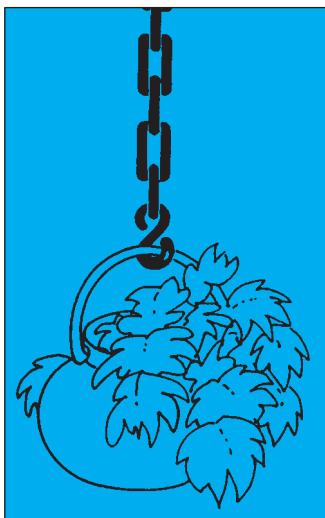

Druh č.	U13	D19	151	D2ELG
Průměr drátu (mm)	1,0	1,1	1,0	1,3

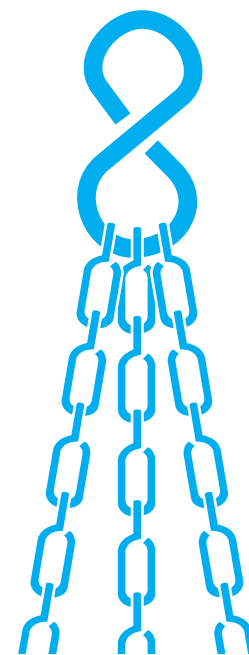

**Závěsný řetízek
D2ELG**

Trojzávěs v délce
od 40 do 75 cm - pro květináče

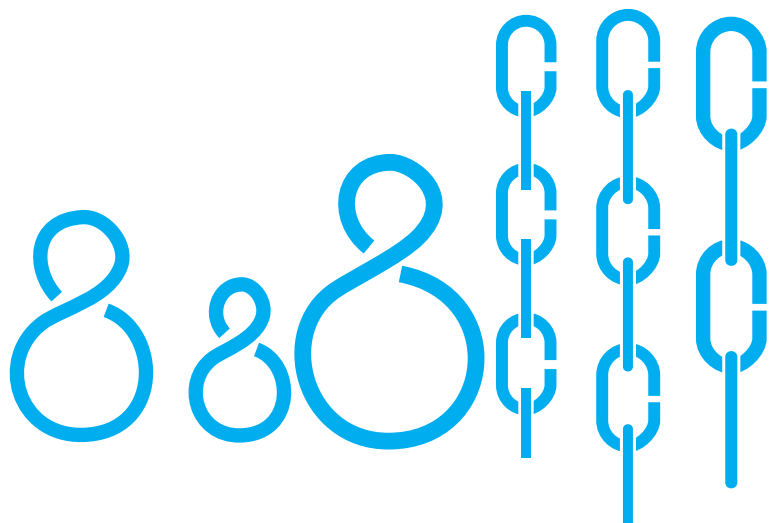

SH109	SH114	SH81	1625K	1601	1603
0604	0614	0605	0024	0001	0003
ø 3,0	2,0	2,8	n 2,0	2,0	1,9

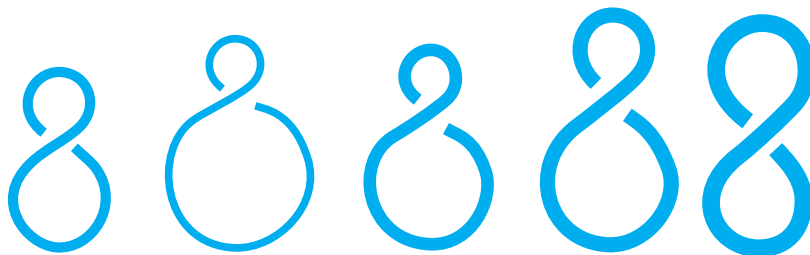
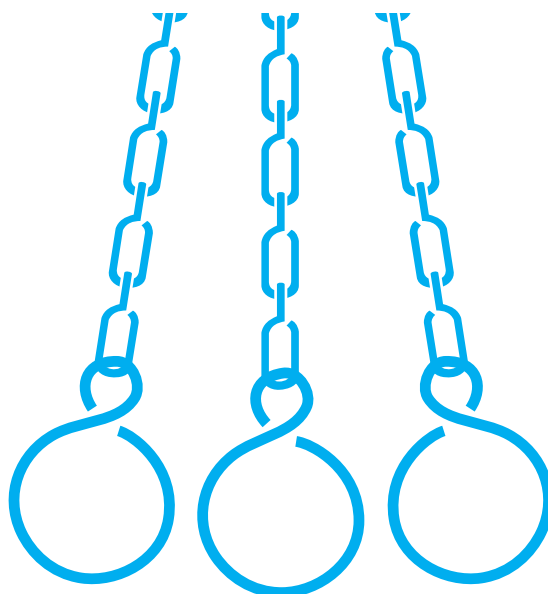

SH115/75	SKT2,0	SH1131/4	SH1091/4	SH97
0652	0643	0600	0603	0623
ø 1,7	2,0	2,3	2,7	2,4

Uvedené zboží je bez atestu.

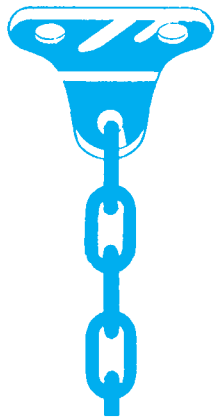

**Svařovaný řetěz
zajišťovací**
- s oboustrannými
úchyty

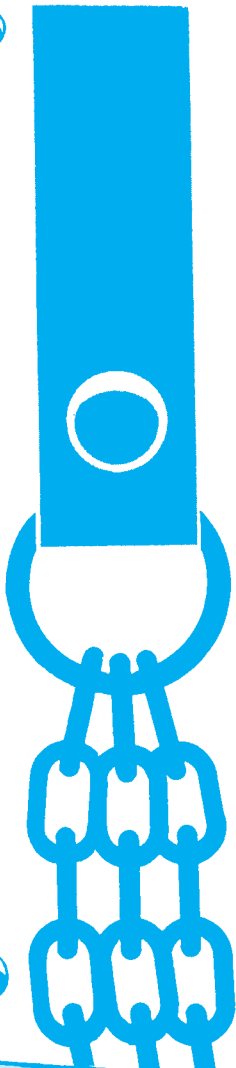
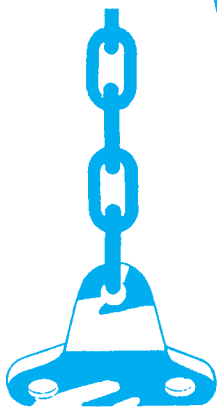

**Pro zedníky, kutily,
pokryvače:**

Trojzávěs
- svařovaný řetěz, galvanicky
pokovený, snýťovaný
v závěsech z kůže

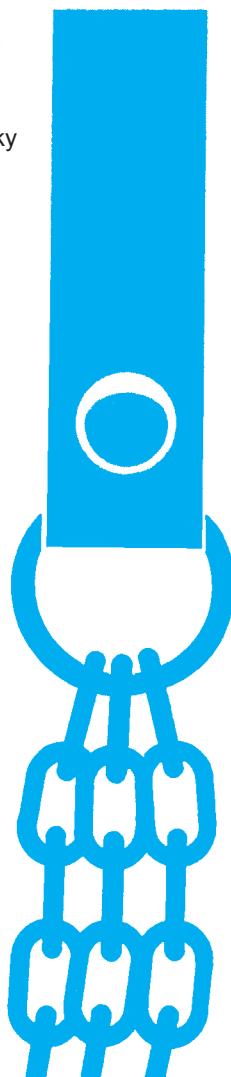

Serižovací řetěz
- do oken a vikýřů

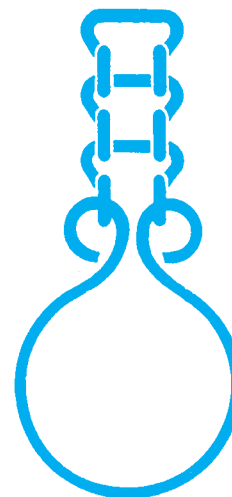

**Zástěrový
řetěz**



K 3/2,4 mm
K 6/3,2 mm
K 10/4,5 mm

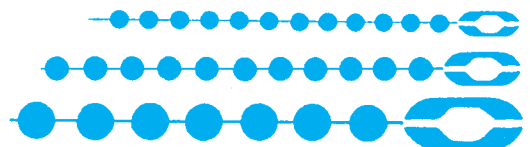

Uvedené zboží je bez atestu.

ŘETĚZY



S-HÁKY



SH 5301
(30 mm)

SH 5367
(35 mm)

Nouzový hák
SH 30/10
(25 mm)

DLOUHÉ HÁKY

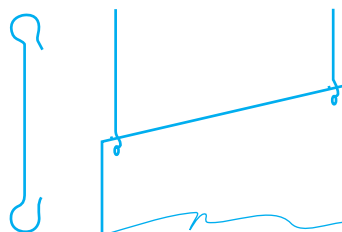

C – HÁKY



ZÁVĚSNÉ HÁKY

Stropní závěsy
9022

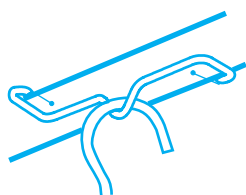

Kroužky DU
DU 25
DU 30
DU 35

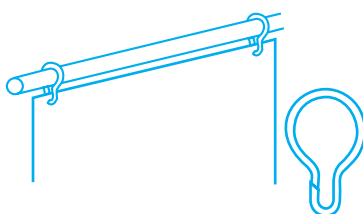

DRŽÁKY PLAKÁTŮ



2535/38 mm /31
se šrouby

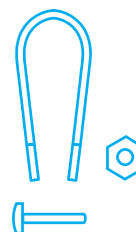

2535/50 mm /31
se šrouby



5221 / 31
25 mm



5222 / 31
30 mm

KARABINY

Karabiny
1/27S / 01



Karabiny
12/30 / 01



Uvedené zboží je bez atestu.

Ocel

00	-	lesklý, bez povrchové úpravy
01	-	poniklovaný
02	-	pomosazený
03	-	pomosazený, brunýrovaný
04	-	poměděný
05	-	poměděný, brunýrovaný
06	-	černě pálený
07	-	dekor „kovaný“
08	-	černě lakovaný
09	-	galvanicky pozinkovaný
10	-	galvanicky pozinkovaný, chromátovaný
11	-	pochromovaný
12	-	pozinkovaný drát DIN 1706
13	-	olověně zbarvený
14	-	pozinkovaný zahorka
15	-	galvanicky pozinkovaný, olověně zbarvený
16	-	pozinkovaný zahorka, černý
17	-	galvanicky pozinkovaný, bíle chromátovaný
18	-	galvanicky pozinkovaný, žlutě chromátovaný
19	-	pozinkovaný drát, černý
20	-	kalený, poniklovaný
21	-	olivově chromátovaný
22	-	kalený, pomosazený
23	-	galvanicky pozinkovaný, černý
24	-	červeně lakovaný
25	-	kalený, pozinkovaný, opláštěný
26	-	bíle lakovaný
27	-	opatřený červeno-bílou vrstvou
28	-	pozinkovaný drát, surový
29	-	surový, nečištěný
50	-	pružinová ocel A, leštěná
51	-	pružinová ocel B, leštěná
54	-	pružinová ocel A, pozinkovaná
55	-	pružinová ocel B, pozinkovaná
56	-	pružinová ocel B, poniklovaná
59	-	pružinová ocel II, lesklá
88	-	opatřený nylonovou vrstvou, barevný
89	-	poniklovaný drát
90	-	pomosazený drát
92	-	zeleně lakovaný
93	-	tmavě modře lakovaný
94	-	světle modře lakovaný

Měď

95	-	surový, nečištěný
96	-	leštěný
91	-	brunýrovaný

Nerezová ocel

40	-	1.4301 leštěný
41	-	1.4301 surový
42	-	1.4303 leštěný
43	-	1.4303 surový
44	-	1.4016 leštěný
45	-	1.4016 surový
46	-	1.4541 leštěný
47	-	1.4541 surový
48	-	1.4436 leštěný
49	-	1.4436 surový
52	-	1.4401 surový
53	-	1.4401 leštěný
57	-	1.4571 surový
58	-	1.4571 leštěný

Hliník

60	-	surový
61	-	niklová barva
62	-	zlatá barva
63	-	staroměděná barva
64	-	bronzová barva
65	-	stříbrná barva
67	-	mosazná barva
68	-	hnědá barva
71	-	černě lakovaný
74	-	bíle lakovaný

Mosaz

30	-	lesklý
31	-	poniklovaný
32	-	galvanicky pozinkovaný, chromátovaný
33	-	pochromovaný
34	-	poměděný, brunýrovaný
35	-	brunýrovaný
36	-	pozinkovaný
38	-	pájený tombakem
39	-	surový, nečištěný

Nové stříbro

97	-	surový, čištěný
----	---	-----------------