

# S36 - kování pro posuvné skříňové dveře

Montáž brzdy  
 (namontujte před nasazením lišty)

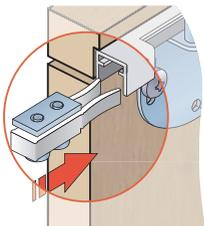

Možnost seřízení  
 horního vozíku

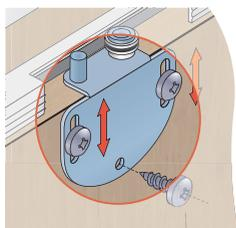

Možnost seřízení  
 dolního vozíku

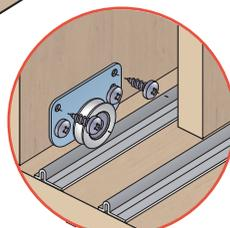
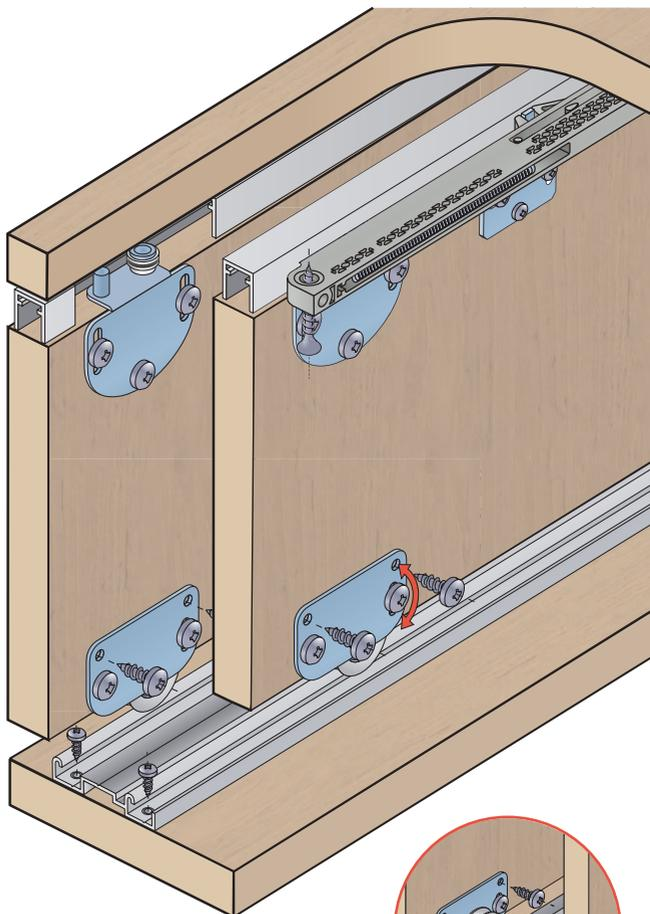
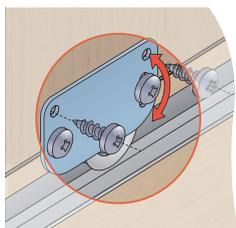

Profil S50 dolní

Sada S36

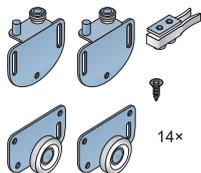

Sada S36 SC

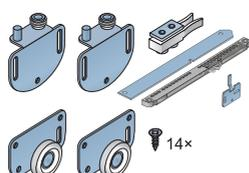

Profil S50 dolní

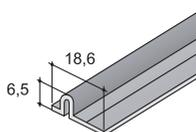

Profil S50 horní

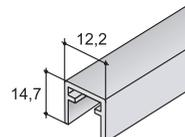

Varianta 1

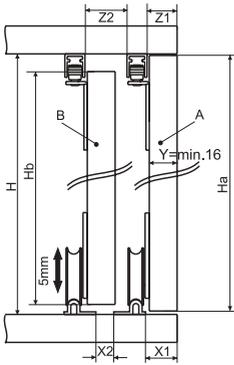

$$\begin{aligned} H_a &= H - \text{min.}4 \\ H_b &= H - 20 \\ X_1 &= Y + 3 \\ X_2 &= Y - 8,5 \\ Z_1 &= Y + 4 \\ Z_2 &= Y + 5 \end{aligned}$$

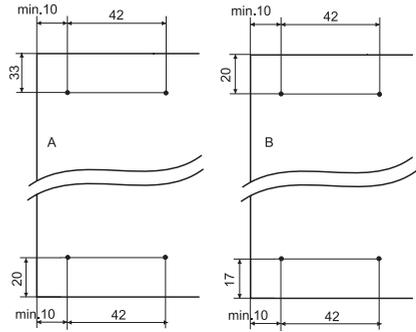

Varianta 2

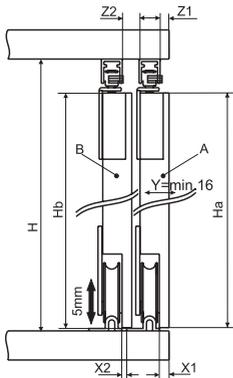

$$\begin{aligned} H_a &= H_b = H - \text{min.}20 \\ X_1 &= Y - 12 \\ X_2 &= Y - 12,5 \\ Z_1 &= Y - 13,5 \\ Z_2 &= Y - 5 \end{aligned}$$

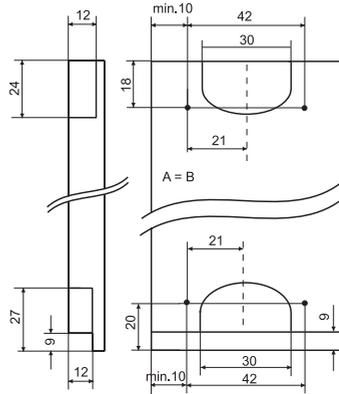

Varianta 3

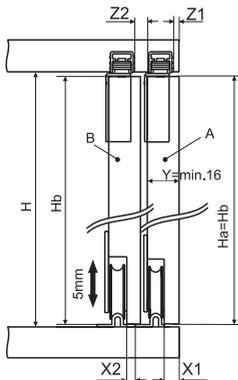

$$\begin{aligned} H_a &= H_b = H - 6 \\ X_1 &= Y - 10 \\ X_2 &= Y - 9,5 \\ Z_1 &= Y - 14,5 \\ Z_2 &= Y - 7 \end{aligned}$$

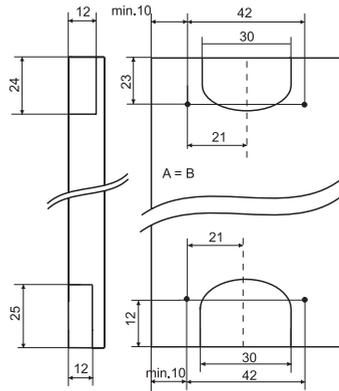

Profil S06

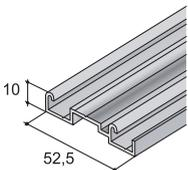

Profil S50 horní  
pro zafrézování

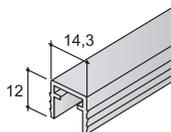

Brzda  
S27/S37AL/S36/S37/S60H

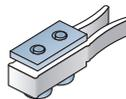

Softclose  
S36/S37 Slidix

